

Wine Rack Assembly Instructions

KINGS BOTTLE

STEP 1 - BOTTOM FRAME

- Assemble the bottom metal frame on a flat surface.
 - Line up and hammer the timber slats into the metal frames using a rubber mallet. Make sure it's fully hammered in.
 - Start from the center.
- ([Instruction Video](#))

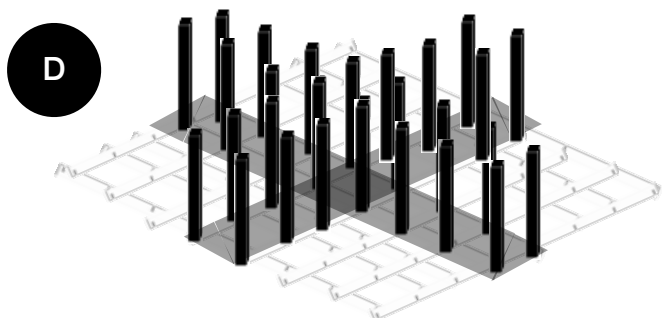
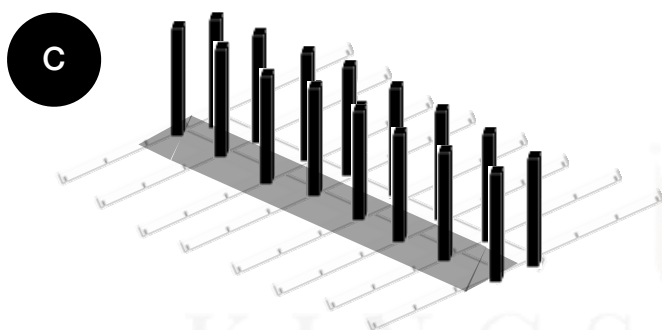
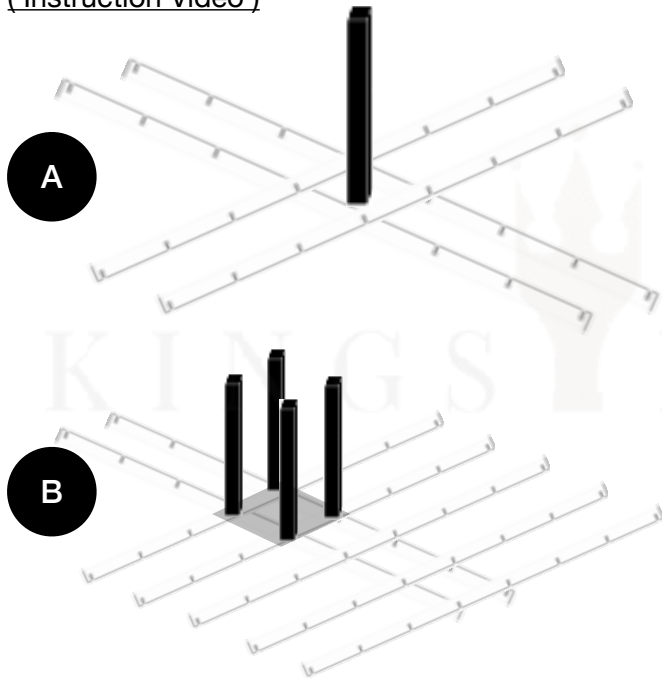

STEP 2 - TOP FRAME

- Insert one section of the metal frame **only halfway** down into the wood pieces.
- ([Instruction Video](#))

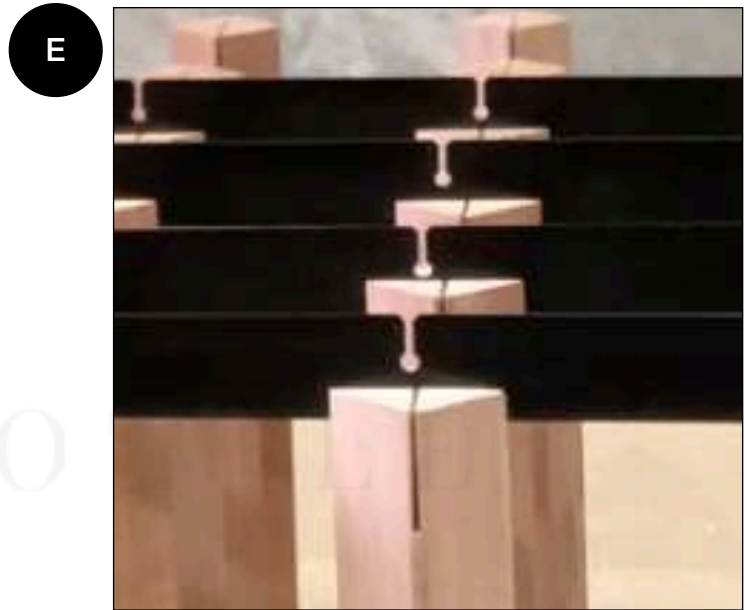

- Insert the 2nd section of the metal frame into the 1st and use a rubber mallet to complete the installation into the wood pieces.

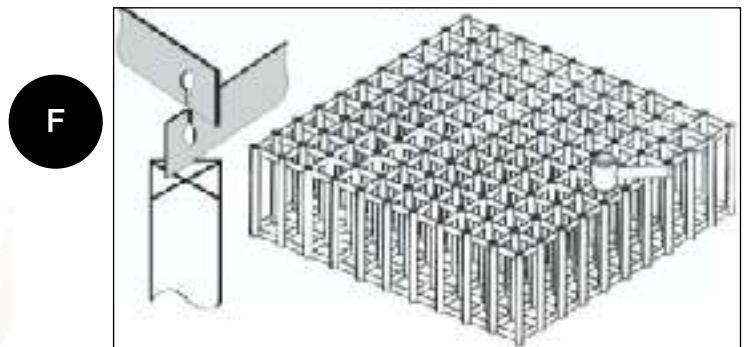

STEP 3 - NECK PROTECTOR

- Snap the bottle neck protectors onto the front side of the metal frame.



ASSEMBLY INSTRUCTIONS _ TYPE-V

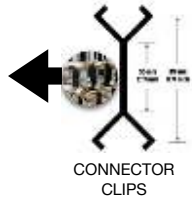
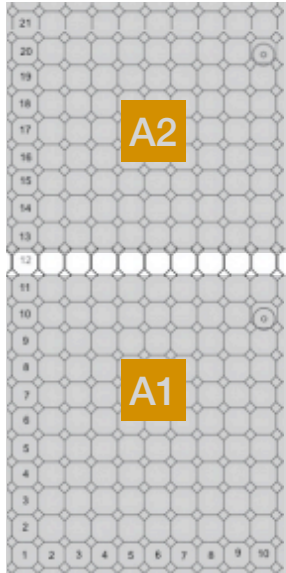

1 Build the wine racks A1, A2

2 **CONNECT (STACK) 2 UNITS VERTICALLY**

a. Attach the plastic PLASTIC CONNECTOR CLIPS to the wooden slats on the **BOTTOM ROW** of A2.

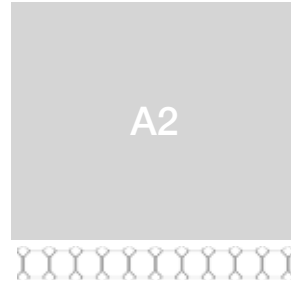

b. Connect A2 to A1, B2 to B1;

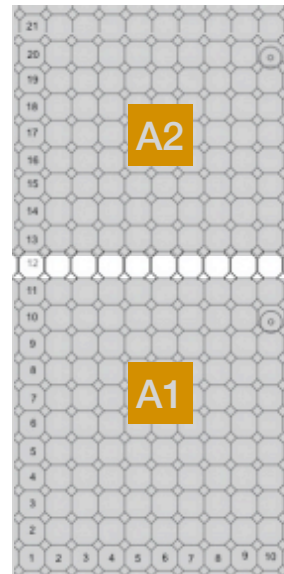

PRODUCT LINKS ON KINGSBOTTLE ONLINE STORES

USA STORE:

[Connector Clips](#)

[Connector Metal Pieces](#)

[Wall Bracket](#)

AUSTRALIA STORE:

[Connector Clips](#)

[Connector Metal Pieces](#)

[Wall Bracket](#)

ASSEMBLY INSTRUCTIONS _ TYPE-H

1 Build the wine racks A1, B1

2 **CONNECT 2 UNITS HORIZONTALLY**

a. Using the **PLASTIC CONNECTOR CLIPS** (red line below), connect A1 to B1, to **fix their positions**.

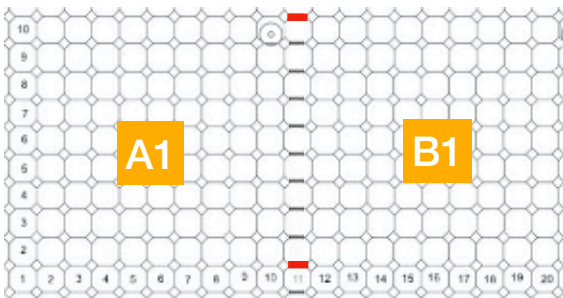
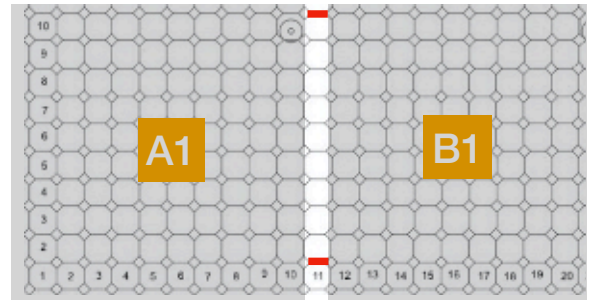
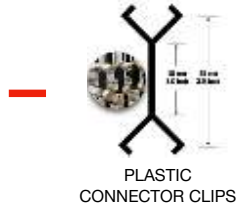

b. Connect A1 to B1, A2 to B2 by inserting the **METAL CONNECTOR PIECES** along the middle column where the **PLASTIC CONNECTOR CLIPS** were inserted in step 2a

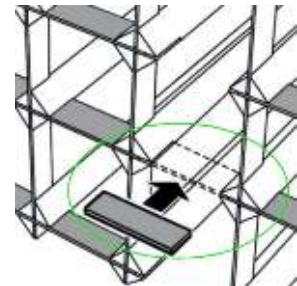
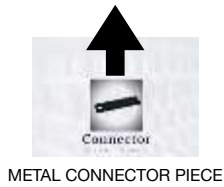

PRODUCT LINKS ON KINGSBOTTLE ONLINE STORES

USA STORE:

[Connector Clips](#)

[Connector Metal Pieces](#)

[Wall Bracket](#)

AUSTRALIA STORE:

[Connector Clips](#)

[Connector Metal Pieces](#)

[Wall Bracket](#)

ASSEMBLY INSTRUCTIONS

1 Build the wine racks A1, A2, B1, B2

2 **CONNECT (STACK) 2 UNITS VERTICALLY**

Attach the **PLASTIC CONNECTOR CLIPS** to the wooden slats on the **BOTTOM ROW** of A2 and B2.
Connect A2 to A1, B2 to B1;

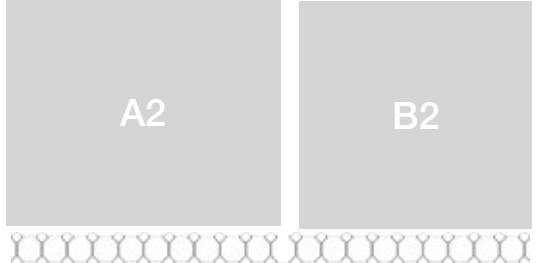

3 **CONNECT 2 UNITS HORIZONTALLY**

a. Using the **PLASTIC CONNECTOR CLIPS** (red line below), connect A1 to B1, A2 to B2, to **fix their positions**.

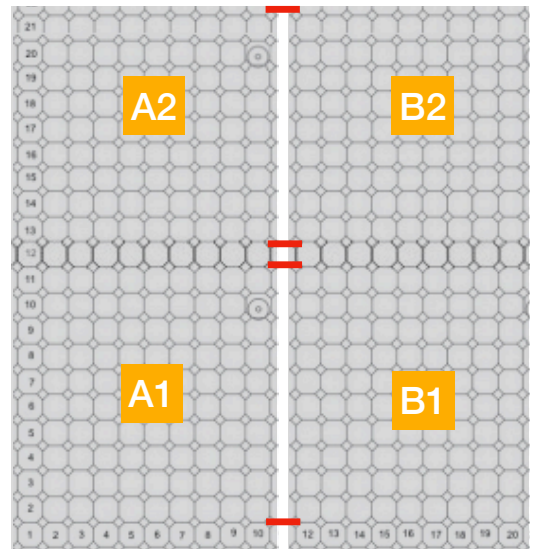

b. Connect A1 to B1, A2 to B2 by inserting the **METAL CONNECTOR PIECES** along the middle column where the **PLASTIC CONNECTOR CLIPS** were inserted in step 3a

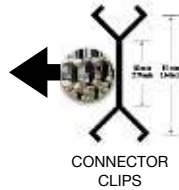
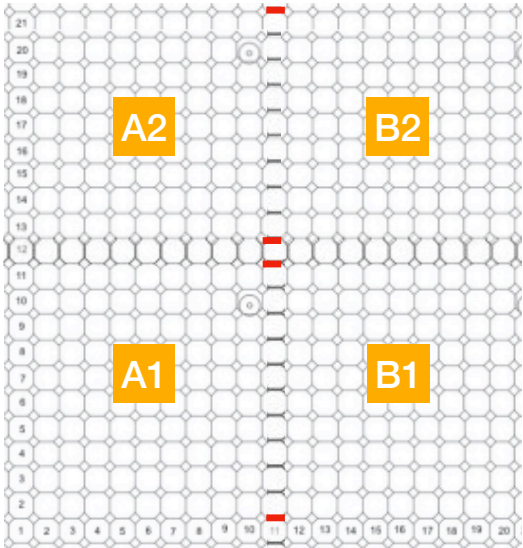
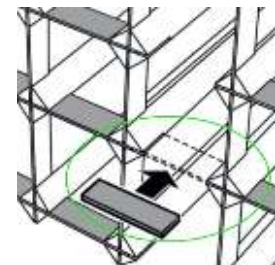

PRODUCT LINKS ON KINGSBOTTLE ONLINE STORES

USA STORE:

[Connector Clips](#)

[Connector Metal Pieces](#)

[Wall Bracket](#)

AUSTRALIA STORE:

[Connector Clips](#)

[Connector Metal Pieces](#)

[Wall Bracket](#)

INSTALLATION INSTRUCTIONS



Wall Bracket

W i t h F i x i n g s

Length: 9.26" (235mm)

The wall brackets are used to firmly connect the wine rack to the adjacent wall. It is recommended to have 4 brackets per square meter (10 sqft), which is around 100 holes/bottles, or 4 brackets per unit (one at each corner).



Move the wine racks to the desired location. Mark the position where the wall brackets will be installed.

Drill the holes in the wall, then insert only the plastic portion.



Hook the wall bracket to the front frame of the wine racks



Screw in.