

# Vino Pins Flex System

Installation guide for the Vino Series Flex (VP-Flex) products



## Before you begin



3D-GUIDED INTERACTIVE ASSEMBLY INSTRUCTIONS CAN BE FOUND ON **BILT**®

DOWNLOAD THE **FREE** APP  
SCAN THE QR CODE TO FIND YOUR PRODUCT



### Included:

- (1) Vino Pins Flex Neck Mounting Strip
- (1) Vino Pins Flex Base Mounting Strip
- (6) Mounting Hole Caps
- (2) Plastic Couplers
- (4) Spiral Drywall Anchors
- (6) Screws

### Additional Components:

*(may be sold separately)*

- Vino Pins
- Vino Pins Extensions (optional)

### Required Tools:

- Phillips head screwdriver
- Level
- Pencil

- Tape measure
- Drill
- 1/2" Drill bit (spade)
- 1/16" Drill bit
- Protractor or adjustable level for angled installs

### Important Note:

These installation instructions will assist you with installing the VintageView Vino Pins Flex System into wood-backed or drywall surfaces.

### Surfaces:

Drywall and wood surfaces must be a minimum of 1/2" (12.7mm) thick.

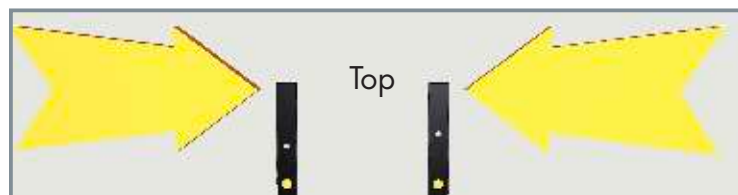
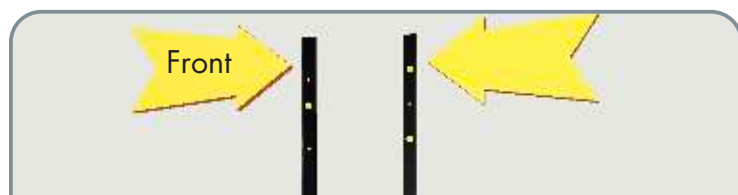

### 1. ORIENT THE MOUNTING STRIPS

Identify the front and top of each mounting strip, then note which of the two is for Vino Pins Neck pieces.

The front of the Mounting Strip has more 1/4" (6.5mm) holes than 1/2" (13mm) holes.

To identify the top of each Mounting Strip, note the side with the 1/2" (13mm) mounting holes closer to the top.

Finally, the neck side of the mounting strip has the higher (offset) of the 1/4" (6.5mm) holes.



Figure A

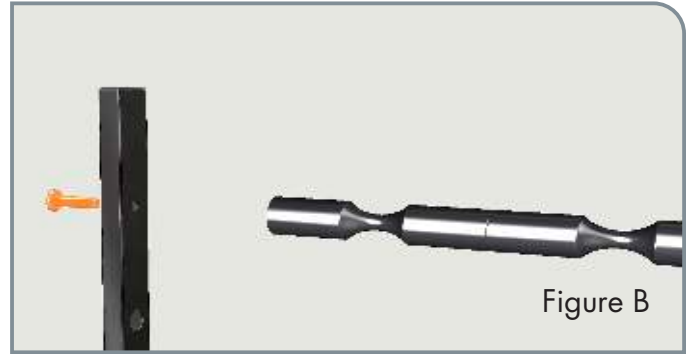

Figure B

**(OPTIONAL)**

**2. ADD VINO PINS EXTENSION PIECES**

Thread one (1) Stud into each Vino Pin Extension for the Bottle Neck (Figure A). Repeat the process for the Vino Pin Bottle Base side. Vino Pins are designed to extend up to three (3) total bottles deep for 750ml bottles and up to two (2) bottles deep with spacer for magnum bottles.

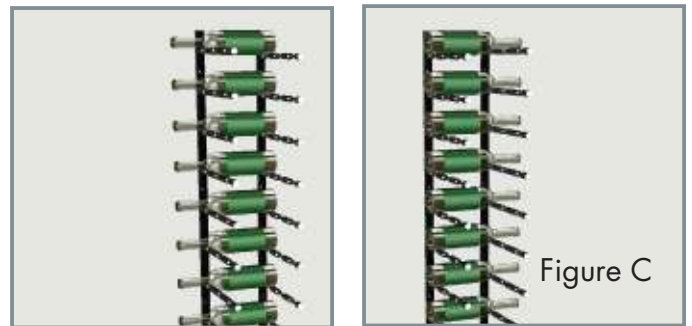

Figure C

**3. ASSEMBLE THE PINS TO THE STRIP**

Insert one (1) Vino Series Screw through the back of one (1) Vino Pins Flex Neck mounting Strip and thread one (1) Vino Pin Neck piece until tight against the surface of the mounting strip (Figure B). Repeat until all Vino Pins Neck pieces are attached to the Neck Mounting Strip, and all Vino Pins Base pieces are attached to the Base Mounting Strip.



Figure D

**4. CHOOSE BOTTLE DIRECTION**

Before marking the mounting hole locations, decide which direction you want the bottle necks to face to determine which order to mount the Base and Neck Mounting Strips (Figure C).

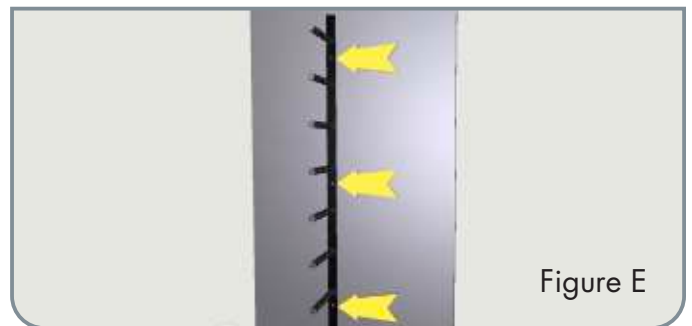

Figure E

**5. LAY OUT WALL**

The Vino Pins Flex can be mounted vertically or at angles ranging from 45 degrees to 135 degrees.

**Vertical Columns**

Starting at least 2 3/4" (70mm) from adjacent wall or other obstructions and 1" (25.5mm) from the ceiling, mark the centerline of the first Mounting Strip (Figure D). From there, measure the distance, noted in chart below by bottle type, to centerline of the second Mounting Strip.

Hold one Mounting Strip (careful to note the top and Neck side) in place against the wall, centered on the first mark at your preferred distance from floor.

Ensure the Strip is plum using a level and mark hole locations with a pencil (Figure E). Mounting Strips can be installed on angles up to 45 degrees. Set strip aside.

**Centerline Measurements**

- Vino Pins Standard (750ml): 7.5" (190.5mm)
- Vino Pins Magnum (1.5L): 8.5" (216mm)





## Angeled Columns

Using a speed square or protractor, hold the first Mounting Strip in desired location set to preferred angle. Mark mounting holes (Figure F). For second Mounting Strip locations use a level to measure across, from the center of the mounting locations of the first Strip, the distance noted on previous page.

The Neck side mounting holes should be offset 3/8" below the Base side.

Pro tip: Test the fit of irregularly shaped bottles by checking your layout angles on the floor first.

\*NOTE: The tops of the Vino Pins Flex Mounting strips will not be flush in angled installs.

## 6. DRILL MOUNTING HOLES

Drill 1/16" (1.5mm) pilot holes at marked locations to determine if installing into wood studs or drywall.

If Drywall: For top mounting point, drill a 1/2" (12.7mm) hole for toggle bolt. For lower two holes use a Phillip's head screwdriver to insert spiral drywall anchors into wall until it is flush with surface.

## 7. HANG THE MOUNTING STRIP

### Drywall

Remove the expanding nut from toggle bolt and insert through the top mounting hole on your Mounting Strip. With the wings of the nut oriented to fold toward the bolt head, thread the expanding nut onto the bolt so the tip of it starts to protrude from the end of the nut (Figure G).

Hold the strip so the toggle bolt aligns with the top mounting and gently push the nut through the wall. Ensure the wings have fully expanded on the backside of the wall and gently tighten, verifying the necks remain level. Secure the rest of the strip through the bottom two mounting holes with provided screws (Figure H).

Fully tighten the toggle bolt using a screwdriver.

### Wood or Studs

Use provided screws and install the Mounting Strip to the wall at the marked mounting hole locations (Figure I).



Figure F

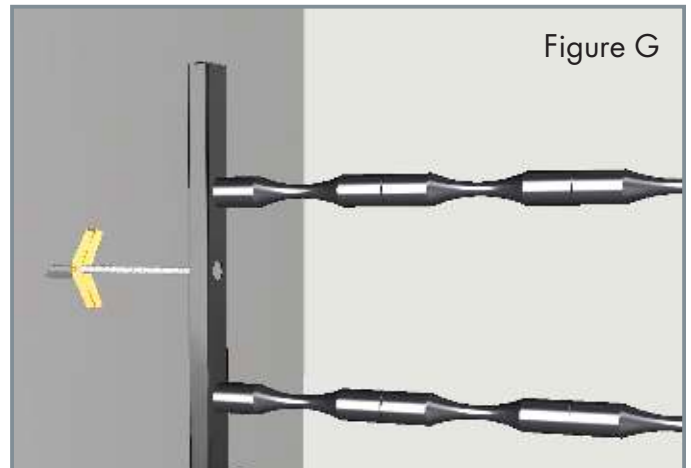

Figure G



Figure H



Figure I



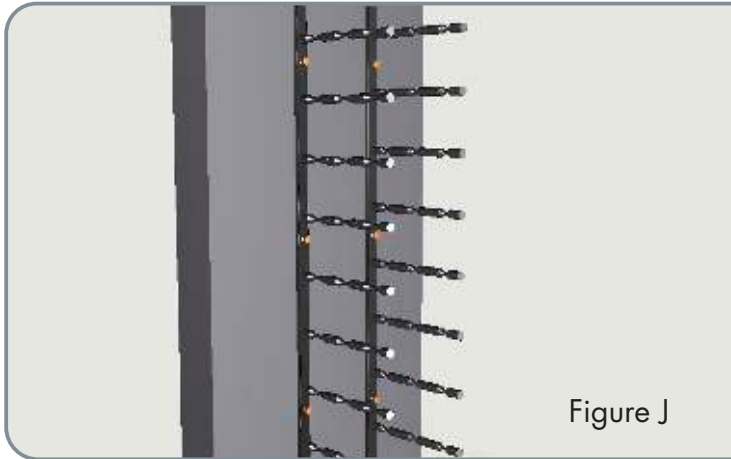

Figure J



### 8. HANG THE NEXT MOUNTING STRIP

Repeat steps 5-8 with the second Mounting Strip, centering it horizontally with the second mark on your wall from Step 4 (vertical installations, ensure tops of Strips are even).

### 9. INSTALL MOUNTING HOLE CAPS

Press supplied mounting hole caps into the open holes of the face of each Mounting Strip (Figure J).

### 10. ADD WINE

Only the good stuff.

### Problems?

Try Vino Pins Flex installation using BILT 3D intelligent instructions, visit [www.vintageview.com](http://www.vintageview.com) or give us a call at 303-504-9463.

### Maintenance and Care:

Vino Series wine racks are backed by a lifetime warranty. They should be regularly checked for tightness. Should any piece to be found to be loose, tighten by hand until secure. If the face of the wall surface shows signs of breakage, discontinue use immediately until the wall may be adequately repaired. Vino Series products may be cleaned with a damp cloth and mild dish soap — abrasive pads or steel wool should NOT be used as they will damage the finished surfaces of the parts.

SCAN FOR BILT 3D INSTRUCTIONS



POWERED BY BILT INTELLIGENT INSTRUCTIONS®

