



The miracles of science™



Refrigerant Piping Handbook

by

Garth Denison



Suva[®]
refrigerants

Acknowledgements

The author wishes to acknowledge the contribution of various friends, co-workers and former colleagues. Gino DiFebo, Nick Reggi, Wesley Taylor and Laurence White enriched the pages of this work with their perspectives and knowledge. It was their participation, discussions, review and comments that made this publication possible.

Dedication

To the advancement of the profession and its members.



Table of Contents

Engineering Data	Section One
Piping Losses	Section Two
Nomographs	Section Three
Piping Procedures	Section Four
Expansion / Contraction	Section Five
Best Practices	Section Six
Quick Pick Criteria	Section Seven
HFC Quick Pick Tables	Section Eight
HCFC Quick Pick Tables	Section Nine
CFC Quick Pick Tables	Section Ten



The miracles of science™

Engineering Data

Section 1



Engineering Data



Engineering Data ... Section One

Design Goals	page 3
Application Considerations	page 5
Code Regulations	page 6
General Design Principles	page 7
Capacity versus Pressure Drop	page 8
Equivalent Lengths	page 9
Copper Tubing Specifications	page 10
Weight of Refrigerant in Copper	page 11
Refrigerant Receivers	page 12
Temperature / Pressure tables	page 13
Refrigeration Piping Schematics	page 14
TEL Work Sheets	page 16
Glossary of Terms	page 18



Refrigerant Piping

Design Goals

A common goal is to size the Suction, Hot Gas and Liquid lines for about 1F° pressure drop at design capacity.

A Suction line must:

- return oil from the evaporator to the compressor at minimum system capacity.
- prevent oil draining from an active to an inactive evaporator when more than one evaporator is used in a single system.
- dampen or eliminate line vibrations and noise cause by compressor vibration.
- minimize line sweating from condensation.
- prevent unnecessary heat gain into the refrigerant.

The Hot Gas Discharge line must:

- avoid oil trapping at minimum system capacity.
- prevent backflow of oil or liquid refrigerant to the compressor during low capacity or shutdown.
- dampen or eliminate line vibration and noise caused by gas pulsations and compressor vibration.

continued ...



Refrigerant Piping

Design Goals

The Liquid line must prevent:

- formation of flash gas upstream of the metering device.
- heat gain to the refrigerant.

The refrigerant Condensate line must:

- provide sewer-type flow; that is, free draining of liquid refrigerant in one direction, while refrigerant vapour flows adjacent to the liquid in the other direction.

The Hot Gas Defrost line must:

- maintain sufficient refrigerant flow rate. The velocity determined at saturated conditions will result in a conservative line size.
- be properly sized to handle the calculated needed hot gas load, this is based on twice the evaporator flow rate.
- prevent condensed liquid refrigerant from backflow to the compressor while on defrost or shutdown.

Good refrigeration piping design requires that the refrigeration lines be pitched in the direction of flow at approximately 1/2 inch per 10 feet or 1 inch per 20 feet.

Refrigerant velocities in vertical lines should be at least 1500 ft/min to ensure good oil return; velocities in horizontal lines should be at least 750 ft/min.



Refrigerant Piping

Application Considerations

- System design for MINIMUM pressure drop.

Pressure loss results in:

- a. decrease in thermal capacity
 - b. increase power requirements (see page 8)
- Refrigerant being piped DOES NOT change state.
 - Lubricants are miscible with refrigerants.
 - minimize the accumulation of liquid refrigerant in compressor crankcase
 - oil returns to compressor at same rate which it leaves



Refrigerant Piping

Code Regulations

Design should conform to all codes, law and regulations that apply at the “SITE” of the installation.

Examples:

Mechanical Refrigeration Code .. CSA B52

Canadian Building Code

ASHRAE 15

Municipal / State / Provincial Codes

OEM’s Recommended Installation Guidelines



Refrigerant Piping

General Design Principles

- Ensure proper feed to evaporators.
- Practical line sizes without excessive pressure drop.
- Protect compressor by:
 - preventing excessive oil from being trapped in a system.
 - minimizing oil loss from the compressor.
 - preventing liquid refrigerant or oil from entering the compressor while operating or while on the off cycle.
 - maintaining a clean and dry system.



Refrigerant Piping

Capacity Versus Line Pressure Drop

Vapour Lines

	Capacity %	HP/Ton %
No line loss	100.0	100.0
2F ° Suction line	95.7	103.5
2F ° Hot gas discharge line	98.4	103.5
4F ° Suction line	92.2	106.8
4F ° Hot gas discharge line	96.8	106.8

Liquid Lines

Pressure drop not as critical as in vapour lines.

Pressure drop should not cause:

- vapour formation in line
- insufficient liquid pressure at DX device

Typical liquid line pressure drop no greater than 1F° change in refrigerant temperature.



Refrigerant Piping

Equivalent Lengths of Nonferrous Valves and Fittings

Equivalent Length is expressed in Feet of Pipe

Line Size OD	Globe / Solenoid Valve	Angle / Check Valve	90 ° SR Elbow	90 ° LR Elbow	45 ° Elbow	Tee Line / Sight Glass	Tee Branch	Enlarging Coupling			Reducing Coupling		
								1/4	1/2	3/4	1/4	1/2	3/4
1/2	9	5	1.4	0.9	0.4	0.6	2.0	1.4	0.8	0.3	0.7	0.5	0.3
5/8	12	6	1.5	1.0	0.5	0.8	2.5	1.8	1.1	0.4	0.9	0.7	0.4
3/4	14	7	1.9	1.3	0.6	0.9	3.0	2.5	1.5	0.5	1.2	1.0	0.5
7/8	15	8	2.3	1.5	0.7	1.0	3.5	3.2	2.0	0.7	1.6	1.2	0.7
1 1/8	22	12	2.7	1.8	0.9	1.5	4.5	4.7	3.0	1.0	2.3	1.8	1.0
1 3/8	28	15	3.6	2.4	1.2	1.8	6.0	5.8	3.6	1.2	2.9	2.2	1.2
1 5/8	35	17	4.2	2.8	1.4	2.0	7.0	8.0	4.8	1.6	4.0	3.0	1.6
2 1/8	45	22	5.9	3.9	1.8	3.0	10.0	10	6.1	2.0	5.0	3.8	2.0
2 5/8	51	26	6.9	4.6	2.2	3.5	12.0	13	8.0	2.6	6.5	4.9	2.6
3 1/8	65	34	7.7	5.5	2.7	4.5	15.0	15	9.2	3.0	7.7	6.0	3.0
3 5/8	80	40	9.8	6.5	3.0	5.0	17.0	17	11	3.8	9.0	6.8	3.8

Muller Brass Co. Data

Carrier Engineering Manual number 3

Note: General accepted industry practice for determining the equivalent lengths for both P traps and U Bends is to add *two* 90° LR elbows of the specific OD tubing size for each component used.

Enter table for losses at smallest diameter “d”



Refrigerant Piping



Copper Tubing Specifications

Nominal (OD) Diameter	Type	Diameter		Flow Area sq. In.	Weight Lb/Lin Ft.
		OD In	ID In		
3/8	K	0.375	0.305	0.073	0.145
	L	0.375	0.315	0.078	0.126
1/2	K	0.500	0.402	0.127	0.269
	L	0.500	0.430	0.145	0.198
5/8	K	0.625	0.527	0.218	0.344
	L	0.625	0.545	0.233	0.285
3/4	K	0.750	0.652	0.334	0.418
	L	0.750	0.666	0.348	0.362
7/8	K	0.875	0.745	0.436	0.641
	L	0.875	0.785	0.484	0.455
1 1/8	K	1.125	0.995	0.778	0.839
	L	1.125	1.025	0.825	0.655
1 3/8	K	1.375	1.245	1.22	1.040
	L	1.375	1.265	1.26	0.884
1 5/8	K	1.625	1.481	1.72	1.36
	L	1.625	1.505	1.78	1.14
2 1/8	K	2.125	1.959	3.01	2.06
	L	2.125	1.985	3.10	1.75
2 5/8	K	2.625	2.435	4.66	2.93
	L	2.625	2.465	4.77	2.48
3 1/8	K	3.125	2.907	6.64	4.00
	L	3.125	2.945	6.81	3.33
3 5/8	K	3.625	3.385	9.00	5.12
	L	3.625	3.425	9.21	4.29
4 1/8	K	4.125	3.557	11.7	6.51
	L	4.125	3.905	12.0	5.38

Based on ASTM B-88 standard

Maximum Spacing Between Pipe Supports for Copper Tubing

Nominal (OD) Diameter	<u>Max.</u> Span in Ft.
5/8	5
7/8	6
1 1/8	7
1 3/8	8
1 5/8	9
2 1/8	10
2 5/8	11
3 1/8	12
3 5/8	13
4 1/8	14

1967 ASHRAE Guide and Data Book

① Maximum allowable hanger distance as per CSA B52 code



Weight of Refrigerant in Copper Tubing

Pounds per 100 feet of Type K & L Tubing

(Weight at 77°F / 25°C)



Tube O.D.		Flow Area sq. in	Cu ft / 100ft	R-12		R-22		R-500		R-502		R-134a		R-401A		R-402A		R-404A		R-407C		R-410A	
				81.84 L (1)	2.32 V	74.53 L	2.76 V	72.16 L	2.29 V	75.95 L	4.16 V	75.28 L	2.02 V	74.52 L	1.81 V	71.86 L	4.32 V	65.45 L (3)	4.00 V	70.80 L	2.62 V	66.32 L	4.12 V
1/2	K	0.127	0.088	7.2	0.20	6.6	0.24	6.4	0.20	6.7	0.37	6.6	0.18	6.6	0.16	6.3	0.38	5.8	0.35	6.2	0.23	5.8	0.36
	L	0.145	0.101	8.3	0.23	7.5	0.28	7.3	0.23	7.7	0.42	7.6	0.20	7.5	0.18	7.3	0.44	6.6	0.40	7.2	0.26	6.7	0.42
5/8	K	0.218	0.151	12.4	0.35	11.3	0.42	10.9	0.35	11.5	0.63	11.4	0.31	11.3	0.27	10.9	0.65	9.9	0.60	10.7	0.40	10.0	0.62
	L	0.233	0.162	13.3	0.38	12.1	0.45	11.7	0.37	11.7	0.67	12.2	0.37	12.1	0.29	11.6	0.70	10.6	0.65	11.5	0.42	10.7	0.67
3/4	K	0.334	0.232	19.0	0.54	17.3	0.64	16.7	0.53	17.6	0.97	17.5	0.47	17.3	0.42	16.7	1.00	15.2	0.93	16.4	0.61	15.4	0.96
	L	0.348	0.242	19.8	0.56	18.0	0.67	17.5	0.55	18.4	1.01	18.2	0.49	18.0	0.44	17.4	1.05	15.8	0.97	17.1	0.63	16.0	1.00
7/8	K	0.436	0.303	24.8	0.70	22.6	0.84	21.9	0.69	23.0	1.26	22.8	0.61	22.6	0.55	21.8	1.31	19.8	1.21	21.5	0.79	20.1	1.25
	L	0.484	0.336	27.5	0.78	25.0	0.93	24.2	0.77	25.5	1.40	25.3	0.68	25.0	0.61	24.1	1.45	22.0	1.34	23.8	0.88	22.3	1.38
1 1/8	K	0.778	0.540	44.2	1.25	40.2	1.49	39.0	1.24	41.0	2.25	40.7	1.09	40.2	0.98	38.8	2.33	35.3	2.16	38.2	1.41	35.8	2.22
	L	0.825	0.573	46.9	1.33	42.7	1.58	41.3	1.31	43.5	2.38	43.1	1.16	42.7	1.04	41.2	2.48	37.5	2.29	40.7	1.50	38.0	2.36
1 3/8	K	1.217	0.845	69.2	1.96	63.0	2.33	61.0	1.94	64.2	3.52	63.6	1.71	63.0	1.53	60.7	3.65	55.3	3.38	59.8	2.21	56.0	3.48
	L	1.257	0.873	71.4	2.03	65.1	2.41	63.0	2.00	66.3	3.63	65.7	1.76	65.1	1.58	62.7	3.77	57.1	3.49	61.8	2.29	57.8	3.60
1 5/8	K	1.723	1.197	97.9	2.78	89.2	3.30	86.4	2.74	90.9	5.00	90.1	2.42	89.2	2.17	86.0	5.17	78.3	4.79	84.7	3.14	79.4	4.93
	L	1.779	1.235	100.1	2.87	92.0	3.41	89.1	2.82	93.8	5.14	93.0	2.49	92.0	2.24	88.7	5.33	80.8	4.94	87.4	3.24	81.9	5.09
2 1/8	K	3.014	2.093	171.3	4.86	156.0	5.78	151.0	4.79	159.0	8.71	157.6	4.23	156.0	3.79	150.4	9.04	137.0	8.37	148.2	5.48	138.8	8.62
	L	3.095	2.149	175.9	4.99	160.2	5.93	155.1	5.93	163.2	8.94	161.8	4.34	160.1	3.89	154.4	9.28	140.7	8.60	152.1	5.63	142.5	8.85
2 5/8	K	4.657	3.234	264.7	7.50	241.0	8.93	233.4	7.41	245.6	13.45	243.5	6.53	241.0	5.85	232.4	13.97	211.7	12.94	229.0	8.47	214.4	13.32
	L	4.772	3.314	271.2	7.69	247.0	9.15	239.1	7.59	251.7	13.79	249.5	6.69	247.0	6.00	238.1	14.32	216.9	13.26	234.6	8.68	219.8	13.65
3 1/8	K	6.637	4.609	377.2	10.70	343.5	12.72	332.6	10.55	350.1	19.17	347.0	9.31	343.5	8.34	331.2	19.90	301.7	18.43	326.3	12.10	305.7	18.99
	L	6.812	4.731	387.2	10.98	352.6	13.06	341.4	13.06	359.3	19.68	356.1	9.56	352.6	8.56	340.0	20.43	309.6	18.92	345.0	12.40	313.8	19.49
3 5/8	K	8.999	6.249	511.4	14.50	465.7	17.25	450.9	14.31	474.6	25.99	470.4	12.62	465.7	11.31	449.1	26.99	409.0	25.00	442.4	16.37	414.4	25.75
	L	9.213	6.398	523.6	14.84	476.8	17.66	461.7	14.65	485.9	26.62	481.6	12.92	476.8	11.58	459.8	27.64	418.7	25.59	453.0	16.76	424.3	26.36
4 1/8	K	11.684	8.114	664.0	18.82	604.7	22.39	585.5	18.58	616.3	33.75	610.8	16.39	604.7	14.68	583.1	35.10	531.1	32.46	547.5	21.26	538.1	33.43
	L	11.977	8.317	680.7	19.30	619.9	22.95	600.2	19.05	631.7	34.60	626.1	16.80	619.8	15.05	597.7	35.93	544.3	33.27	588.8	21.79	551.6	34.27

NOTES: (1). L ... saturated liquid & density, V ... saturated vapour & density, (2). Copper Tubing as per ASTM – B88, (3). for R-507 use R-404A values



Refrigerant Receivers

Suva
refrigerants

(R-22 capacities at 90° F and 90% full.)
Density of R-22 at 90° F is 72.71 lbs per cubic foot

Vertical Receivers

(R-22 capacity in lbs.)

Dia.	length	lbs.
3.5	x 7.5	= 2
3.5	x 10	= 3
4	x 10	= 4
5	x 10	= 6
5	x 20	= 13
6	x 12	= 10
6	x 18	= 16
6	x 24	= 22
6	x 30	= 28

Note: Dia. and Length are in inches

Horizontal Receivers

(R-22 capacity in lbs.)

Dia.	length	lbs.	Dia.	length	lbs.	Dia.	length	lbs.
5	x 28	= 18	9 3/4	x 22	= 51	14	x 72	= 363
						14	x 96	= 489
6	x 30	= 28	10 3/4	x 36	= 105	16	x 60	= 388
6	x 36	= 34	10 3/4	x 48	= 142	16	x 72	= 470
6 5/8	x 38	= 43	10 3/4	x 60	= 179	16	x 96	= 633
			10 3/4	x 72	= 216	18	x 72	= 597
7 5/8	x 28	= 41	10 3/4	x 96	= 290			
			12 3/4	x 48	= 196	20	x 72	= 736
8 5/8	x 28	= 53	12 3/4	x 60	= 248	20	x 84	= 866
8 5/8	x 36	= 69	12 3/4	x 72	= 299	20	x 96	= 996
8 5/8	x 42	= 81	12 3/4	x 96	= 404			
8 5/8	x 48	= 93						
8 5/8	x 60	= 117						

Note: Dia. and Length are in inches

For alternate refrigerant storage capacities in pounds for R-22 rated receivers multiply the rated capacity by the following conversion factors.

Example: A receiver that measures 12 3/4" x 72" has a R-22 rated capacity of 299 lbs.
What is its revised capacity if this receiver is used with R-407C ?
299 lbs x 0.9473 = 283 lbs.

R-22 ... 1.0000	R-401A ... 0.9927	R-404A ... 0.8682	R-410A ... 0.8794
R-123 ... 1.2405	R-401B ... 0.9920	R-407C ... 0.9473	R-507 ... 0.8674
R-124 ... 1.1425	R-402A ... 0.9293	R-408A ... 0.8853	
R-134a ... 1.0114	R-402B ... 0.9433	R-409A ... 1.0278	

Notes: Receivers capacities source Standard Refrigeration Company.
All dimensions are expressed in inches and all weights are expressed in pounds.
Densities sourced from E.I. DuPont Thermodynamic Tables,
R-507 ... AlliedSignal Inc., computer program,
R-408A and R-409A ... Elf Atochem, computer program.



Temperature / Pressure Chart Complete

Range of Temperature Applications



High, Medium and Low Temperature Applications

°F	R-12	R-22	R-502	R-134a	R-404A	R-407C	R-410A	R-507	°C
-50	16"	7"	0	19"	1 0	3" 11"	6	1	-46
-45	14"	3"	2	17"	4 3	1 8"	9	3	-43
-40	11"	0	9	15"	5 5	3 5"	12	6	-40
-35	9"	2	4	13"	8 7	5 1"	15	8	-37
-30	6"	5	7	10"	11 10	8 1	19	11	-34
-25	2"	7	12	7"	14 13	10 4	23	15	-32
-20	1	10	15	4"	17 16	14 6	28	18	-29
-15	2	13	19	0	21 20	17 9	32	22	-26
-10	5	16	22	2	25 24	21 12	38	26	-23
-5	5	20	27	4	29 28	25 15	44	31	-21
0	9	24	31	7	34 33	29 19	50	35	-18
5	12	28	36	9	39 38	34 23	57	41	-15
10	15	33	41	12	45 44	39 27	64	46	-12
15	18	38	46	15	51 49	44 32	72	52	-9
20	21	43	52	19	57 56	50 37	80	59	-7
25	25	49	59	22	64 63	57 43	89	66	-4
30	29	55	66	26	71 70	64 48	99	73	-1
35	33	62	73	31	79 78	71 55	109	81	2
40	37	69	81	35	87 86	79 62	121	90	4
45	42	76	89	40	96 95	87 69	132	99	7
50	47	84	98	46	106 104	96 77	145	108	10
55	52	93	107	52	116 114	106 86	158	119	13
60	57	102	117	58	126 125	116 95	173	129	16
65	64	111	127	64	138 136	127 104	188	141	18
70	70	122	138	71	150 148	139 115	204	153	21
75	77	132	149	79	162 160	151 126	221	166	24
80	84	144	161	87	176 177	163 138	238	180	27
85	92	156	174	95	190 188	177 150	257	194	29
90	100	168	187	104	205 203	191 164	277	210	32
95	108	182	201	114	220 218	206 178	298	226	35
100	117	196	216	124	237 235	222 193	320	243	38
105	127	210	232	135	254 252	239 209	344	261	41
110	136	226	248	146	273 271	257 225	368	280	43
115	147	242	265	158	292 290	275 243	394	300	46
120	158	260	282	171	312 310	294 262	421	322	49
125	169	278	301	184	333 331	315 282	445	344	52
130	181	296	321	199	355 353	336 302	479	368	54
135	193	316	341	213	378 377	358 324	510	392	57
140	207	337	363	229	403 401	381 347	543	418	60
145	220	359	385	246	428 422	405 372	577	446	63

Bubble / Dew Bubble / Dew

Very Low Temperature Applications

° F	R-13	R-503	R-508B	°C
-200				-129
-195				-126
-190				-123
-185				-121
-180				-118
-175				-115
-170				-112
-165				-109
-160				-107
-155				-104
-150		16"	18"	-101
-145		13"	15"	-98
-140		10"	12"	-96
-135		6"	8"	-93
-130		2"	4"	-90
-125	9"	1	0	-87
-120	5"	4	3	-84
-115	1"	7	6	-82
-110	2	10	9	-79
-105	5	13	13	-76
-100	7	17	17	-73
-95	11	22	21	-71
-90	14	26	26	-68
-85	18	32	32	-66
-80	23	38	38	-62
-75	27	44	45	-59
-70	32	51	52	-57
-65	38	58	60	-54
-60	44	67	68	-51
-55	51	75	77	-48
-50	58	85	87	-46
-45	65	95	98	-43
-40	74	107	110	-40
-35	82	119	122	-37
-30	92	132	135	-34
-25	102	146	150	-32
-20	113	160	165	-29
-15	124	176	181	-26
-10	136	193	198	-23
-5	149	211	217	-21

Note: Pressure / °C temperature values are rounded off to the nearest whole number, and the values are expressed in PSIG or inches Hg.



Refrigerant Line Identification

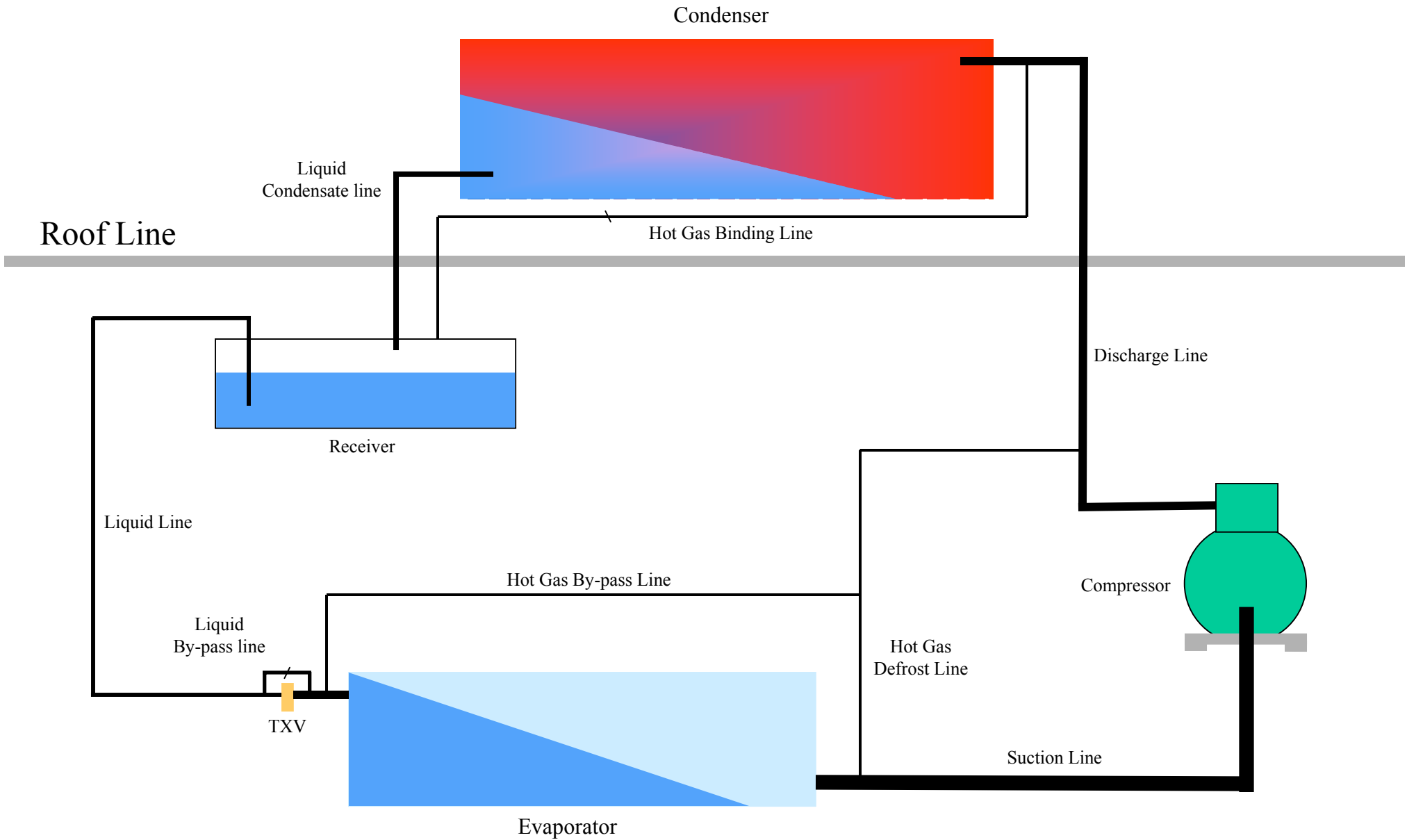



Typical Refrigeration Piping Schematic

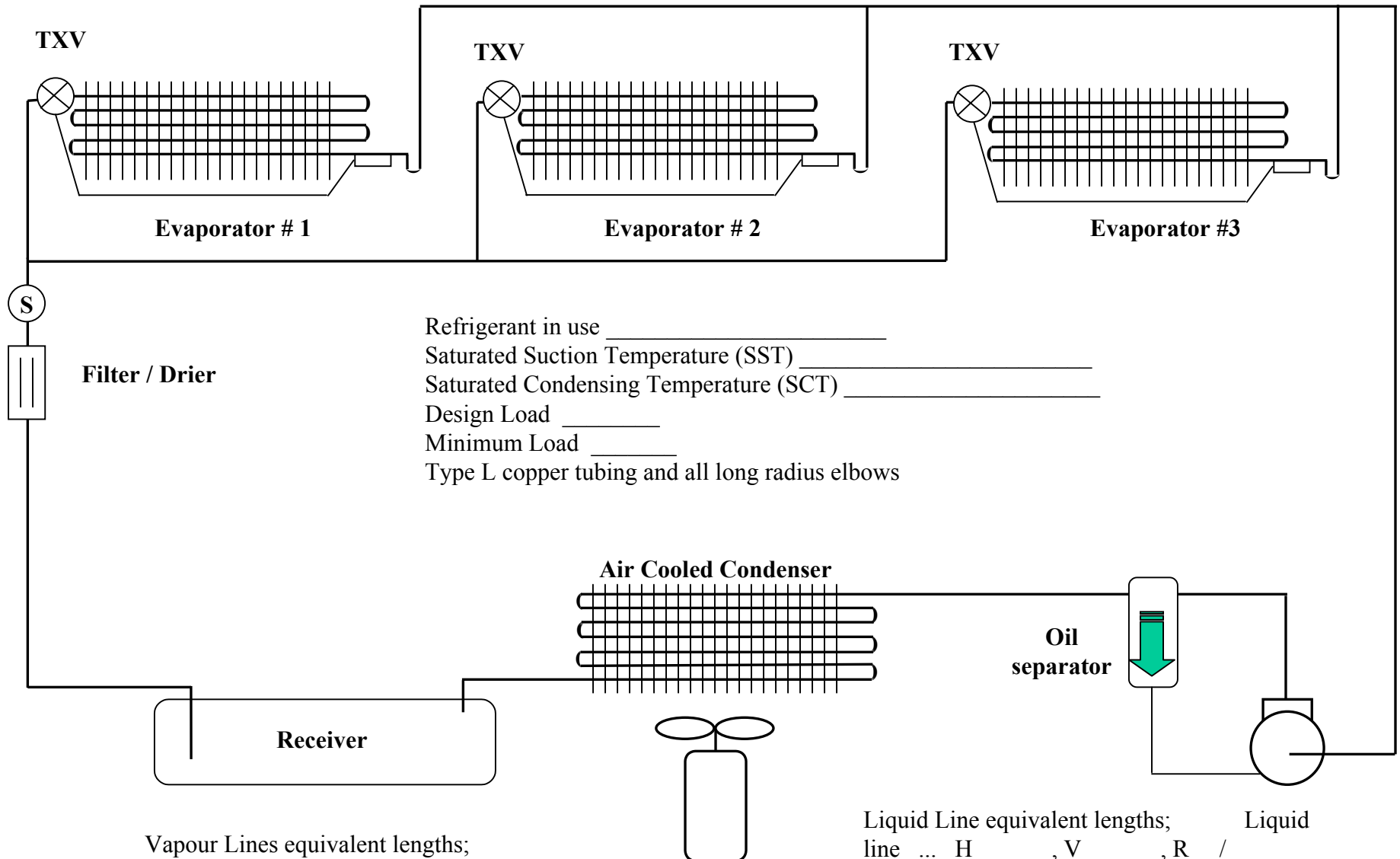

Note: H is horizontal, V is vertical, R is riser



Determining Total Equivalent Lengths



Suction Line

Component Description	Quantity	Size	Equivalent ft./unit	Total Eq. Feet
Actual run of pipe in feet (main)			→	
Actual run of pipe in feet (riser #1)			→	
Actual run of pipe in feet (riser #2)			→	
Short radius elbows (1 st)				
Short radius elbows (2 nd)				
Long radius elbows (1 st)				
Long radius elbows (2 nd)				
Long radius elbows (3 rd)				
Line Flow tee				
Branch Flow tee				
45° elbows				
Globe / Solenoid valve				
Angle / Check valve				
Filter				
Misc:				

Equivalent length of Suction Line → _____ ft.

Discharge Line

Quantity	Size	Equivalent ft./unit	Total Eq. Feet
		→	
		→	
		→	
N/A	N/A	N/A	N/A

Equivalent length of Discharge Line → _____ ft.

Liquid Condensate Line

Quantity	Size	Equivalent ft./unit	Total Eq. Feet
		→	
N/A	N/A	N/A	N/A
N/A	N/A	N/A	N/A
N/A	N/A	N/A	N/A
N/A	N/A	N/A	N/A
N/A	N/A	N/A	N/A
N/A	N/A	N/A	N/A
N/A	N/A	N/A	N/A
N/A	N/A	N/A	N/A

Equivalent length of Liquid Condensate Line → _____ ft.

Sub total # 1 _____ ft.



Determining Total Equivalent Lengths



Liquid Line

Component Description	Quantity	Size	Equivalent ft./unit	Total Eq. Feet
Actual run of pipe in feet (main)			→	
Actual run of pipe in feet (main #2)			→	
Sight glass / Moisture Indicator				
Short radius elbows (1 st)				
Short radius elbows (2 nd)				
Long radius elbows (1 st)				
Long radius elbows (2 nd)				
Long radius elbows (3 rd)				
Line Flow tee				
Branch Flow tee				
45° elbows				
Globe / Solenoid valve				
Angle / Check valve				
Filter				
Misc:				

Equivalent length of **Liquid Line** → _____ ft.

Hot Gas Bypass Line

Quantity	Size	Equivalent ft./unit	Total Eq. Feet
		→	
N/A	N/A	N/A	N/A
N/A	N/A	N/A	N/A
N/A	N/A	N/A	N/A
N/A	N/A	N/A	N/A

Equivalent length of **Hot Gas Bypass Line** → _____ ft.

Hot Gas Defrost Line

Quantity	Size	Equivalent ft./unit	Total Eq. Feet
		→	
N/A	N/A	N/A	N/A
N/A	N/A	N/A	N/A
N/A	N/A	N/A	N/A
N/A	N/A	N/A	N/A

Equivalent length of **Hot Gas Defrost Line** → _____ ft.

Sub total # 2 _____ ft.

Sub total 1 + 2 = **GRAND TOTAL** _____ ft.



Glossary of Terms ...

ACR: Air Conditioning Refrigeration tubing, this tubing has been internally cleaned, sealed and pressurized with dry nitrogen. The specifications are either type K or L copper tubing.

Access Fitting: a fitting that allows a means of accessing the internal pressures within a system.

Ancillary Devices: auxiliary devices pertaining to the system. Examples include but are not limited to the following; sight glasses, mufflers, ORI/ORD, oil separators, receivers, accumulators etc.:

Base Trap: a "P" trap located at the foot of a riser or vertical lift.

Cap Tube: a fixed orifice metering device of various lengths and inside diameter.

Distributor: located after the TXV and will distribute refrigerant through various feeder tubes to actively feed the refrigerant to the evaporator.

Fixed Orifice Device: various forms of metering devices such as; capillary tube, accumulators, orifice plates etc.:

Hangers: devices that are located at a pre-determined distance apart that support and secure the refrigerant piping system.

Insulation: a material installed around the outside diameter of refrigerant tubing that retards the transfer of heat.

Inverted Loop: a loop at the top of a vertical rise that will turn the flow of refrigerant 180 degrees.

continued



Glossary of Terms ...

LR elbow: Long Radius elbow.

NRE: Net Refrigeration Effect. The refrigeration work completed in the evaporator.

OD: the Outside Diameter of the ACR refrigerant tubing being used or specified.

“ P ” Trap: a 180 degree return bend loop located at the bottom of a pipe riser to help insure oil return or help prevent a liquid from settling on the heads of the compressor during it's off cycle.

Piping: the act of doing / installing the required system piping or describing the completed piping system.

Pitch: the slope / grade, 1/2 inch per 10 feet, of the piping run that is pitched in the direction of refrigerant flow.

Pull Box: an enclosed box usually located in the floor, where joints are made when long runs of tubing are used.

SCT: Saturated Condensing Temperature.

Service Valves: valves so located that a service technician using the proper tools will have access to the refrigeration circuit.

Side Inlet T: a device located after the thermostatic expansion valve, before the distributor that will allow for the introduction of hot gas into the evaporator as a means of capacity control.

continued



Glossary of Terms ...

SR elbow: Short Radius elbow.

SST: Saturated Suction Temperature.

TEL: Total Equivalent Length, referring to the individual refrigerant piping run.

TEV / TXV: Thermostatic Expansion Valve.

THR: Total Heat of Rejection, usually the condensers capacity.

Tubing: the actual physical material of construction of a refrigerant piping system. This material is usually ACR tubing and is measured / known by its outside diameter.



Guide Notes:

Suva[®]
refrigerants



The miracles of science™

Piping Losses

Section 2



Refrigerant Piping Losses



Piping Losses ... Section Two

Cause and Effect page 3



Cause and Effect of Pressure Drop

Pressure Loss Results in:

Decrease in Thermal Capacity

Increased Power Requirements

Cause and Effect of Pressure Drop

Pressure drop occurs during fluid flow as a result of frictional forces within the fluid and frictional forces between the moving fluid stream and the stationary pipe walls. The amount of pressure drop depends on a number of variables, including:

- * type of flow, e.g., laminar, turbulent, etc.
- * physical properties of fluid, e.g., viscosity, density, etc.
- * pipe characteristics, e.g., diameter, roughness, etc.
- * velocity of flow in pipe

Pressure drop increases in proportion to the length of pipe. Pressure drop is also increased by anything which disturbs the flow, such as valves, tees, elbows and other fittings.

In refrigerant piping, some pressure drop occurs in both vapour and liquid lines. These pressure drops can have a significant impact on system performance. The effect of these pressure drops must be anticipated and compensation made in the total design.

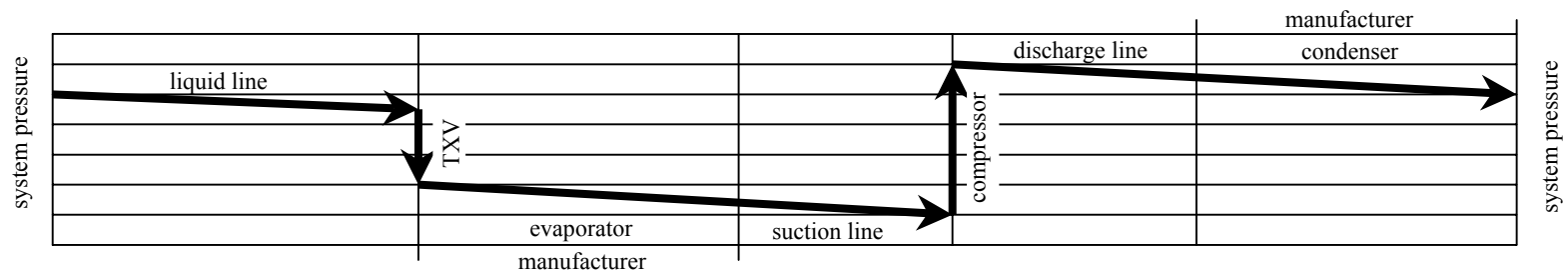

System pressures ... actual pressure changes including the effects of pressure drop



The miracles of science™

Nomographs

Section 3



Refrigerant Piping Nomograph's



Nomographs ... Section Three

What is a nomograph	page 3
Using a nomograph	page 4
Velocity nomograph	page 5
Pressure nomograph	page 6



Nomograph

A graph having three parallel straight lines, each graduated for a different variable so that a straight line cutting all three intersects the related values of each variable. A chart representing numerical relationships.

Before using a refrigerant nomograph you must know the following facts:

- * The system *refrigerant type* (example R-22)
- * System design *capacity* (example 6.0 tons)
- * Saturated Suction Temperature (*SST*) (example - 20° F)
- * Saturated Condensing Temperature (*SCT*) (example 100° F)
- * *Maximum* allowable *pressure drop* for each refrigeration line
- * *Minimum* allowable *velocity* for each refrigeration line

Continued



Nomograph

Using the Refrigerant Pressure Drop or Velocity Nomograph

1. Select the proper nomograph chart.
2. Enter at the design refrigeration capacity at the top of the chart.
3. From the refrigeration capacity location drop vertically until intersecting the saturated evaporator temperature (SST) line, the discharge lines and ending at the saturated liquid line.
4. At this evaporator temperature location draw a horizontal line intersecting the diagonal tubing lines.
5. Select the desired pressure drop or velocity on the saturated condensing temperature line at the bottom of the chart and draw a vertical line to intersect the previously drawn horizontal line.
6. Select the proper suction line tubing size from where these two lines intersect.
7. Confirm the pressure drop in psi per 100 feet or velocity of selected tubing just below the saturated condensing temperature (SCT) line.
8. Repeat the above outline steps for the discharge and liquid lines.



Nomograph

" Velocity "

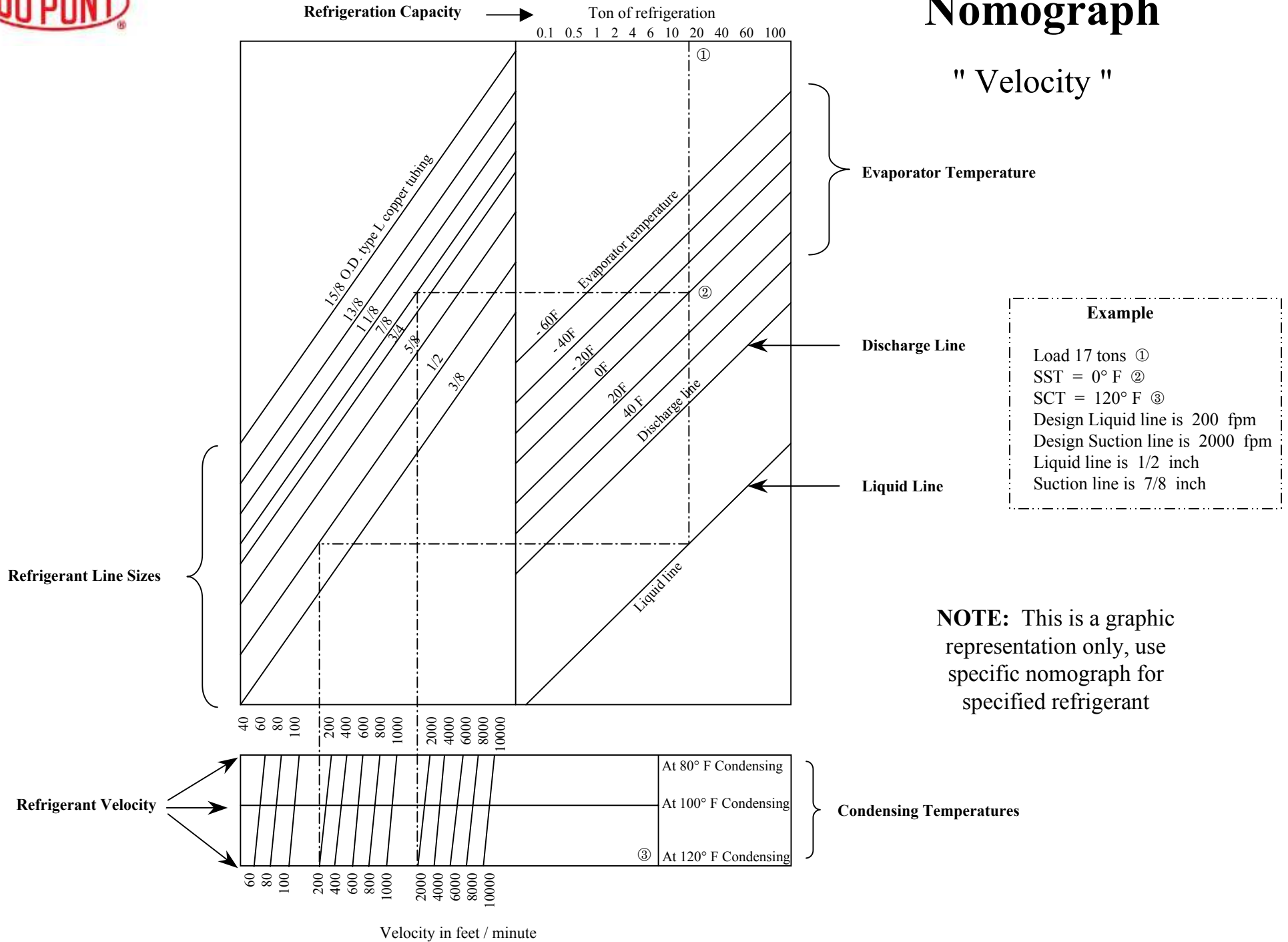

NOTE: This is a graphic representation only, use specific nomograph for specified refrigerant



Nomograph

" Pressure "

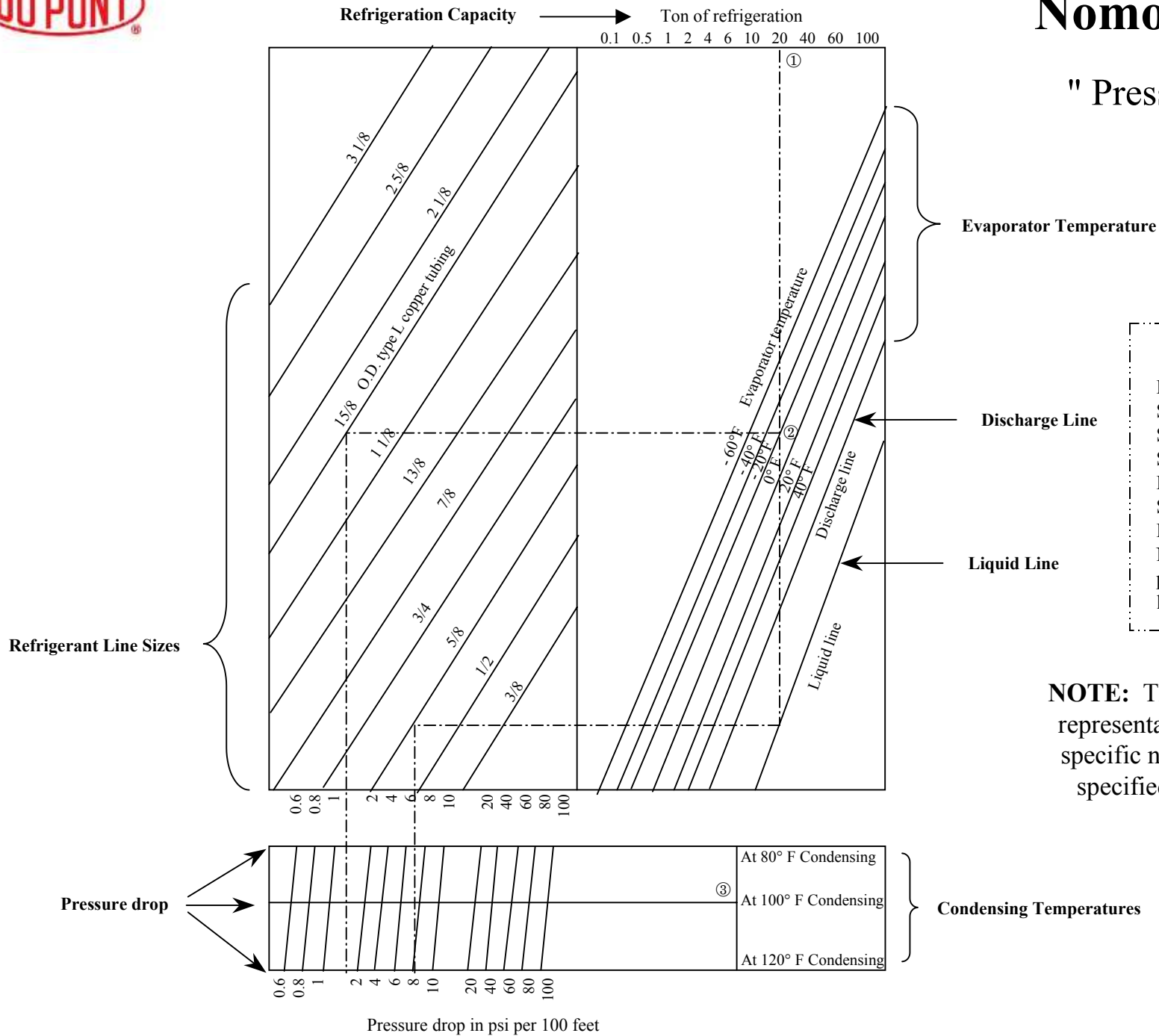

Example

Load 20 tons ①
 SST = minus 20° F ②
 SCT = 100° F ③
 Suction line $\Delta P < 1.5$ psi / 100 ft.
 Liquid line $\Delta P < 7.5$ psi / 100 ft.
 Suction line is 1 5/8 inch
 Liquid line is 5/8 inch
 Note: in this case the liquid line pressure drop would be okay if liquid line was only 20 ft. Long.

NOTE: This is a graphic representation only, use specific nomograph for specified refrigerant



The miracles of science™

Piping Procedures

Section 4



Piping Procedures

Refrigerant piping should be designed and installed to accomplish the "Design Goals" as outlined in this Refrigerant Piping Handbook.



Piping Procedures ... Section Four

Recommended Procedure	page 3
Heat Rejection Factors	page 5
Double Risers	page 6
Double Riser Examples	page 7
Typical Condenser Piping	page 8
Liquid Condensate Piping	page 10
Effects of Height on Pressure	page 11
Pipe Hanger Spacing	page 12



Recommended Procedure for Determining the Proper Refrigerant Pipe Sizes for Typical Refrigeration and Air Conditioning Systems

To carry out these objectives you will require the following:

1. This check list.
2. A pressure / temperature chart for the specified refrigerant.
3. DuPont's Refrigerant Piping "Quick Pick" Handbook.
4. The minimum and maximum design load conditions for this specific refrigeration / air conditioning system.
5. Obtain the saturated suction temperature, saturated condensing temperature for this specific system.
6. Determine the maximum allowable pressure drops expressed in psig for this specific refrigerant at the stated design conditions.
7. Using the accepted industry standard of plus 50 %, determine the approximate equivalent length by making a reasonable estimate of the total equivalent length of tubing for each piping run.
8. Find the preliminary tubing size for each selected piping run.
9. Determine the actual equivalent tube length of each piping run including its fittings and ancillary devices.
10. Calculate the allowable pressure drop based on a **maximum of 2 F degrees for suction vapour lines and 1 F degree for liquid lines.**
11. Add the actual tube length plus the equivalent lengths for all the various fittings and components for each individual pipe run.

continued



Recommended Procedure for Determining the Proper Refrigerant Pipe Sizes for Typical Refrigeration and Air Conditioning Systems

continued

12. Select the suggested tube size from the appropriate "Quick Pick" table for the desired pipe run.
13. Divide the total equivalent length obtained in step 11 above into 100 and multiply by the allowable pressure drop, to determine the pressure drop per 100 feet for the selected line size. Note: the DuPont pressure drop charts are based on 100 feet.
14. If desired plot the actual design situation of the appropriate refrigerant pressure drop and velocity chart. Keep in mind that the pressure drop chart is based on 100 equivalent feet per selected piping run.
15. When the actual pressure drop per 100 feet is determined, divide 100 into the calculated tubing length and multiply by the actual pressure drop per 100 feet. The result will be the actual pressure drop of this selected piping run. The sum of these pressure drops per piping run will determine the total system friction losses.

The above outlined procedure is for **FULL LOAD** conditions. For part load conditions always check your pipe run to insure that you have maintained the minimum recommended velocity of 1500 feet per minute. Keep in mind that double risers can be used on either or both the Hot Gas Discharge Line and the Suction Line to maintain the minimum acceptable velocity of 1500 feet per minute when **PART LOAD** conditions exist.



Heat Rejection Factors

$$\text{Condenser Load} = \text{Compressor Capacity} \times \text{Factor}$$

If heat of rejection figures are not obtainable from the compressor manufacturer, the factors shown in the table below may be used to determine the Total Heat of Rejection (THR).

For systems outside the normal limits of single stage compressor applications, such as compound and cascade refrigeration systems, the following formulae may be used to arrive at the Total Heat of Rejection requirements for the selection of the condenser:

Open Compressors:

$$\text{Total Heat of Rejection} = \text{Compressor Capacity (Btuh)} + (2545 \times \text{BHP}).$$

Suction cooled Hermetic Compressors:

$$\text{Total Heat of Rejection} = \text{Compressor Capacity (Btuh)} + (3413 \times \text{kW}).$$

Evaporator Temperature		Condensing Temperature											
		90° F (32° C)		100° F (38° C)		110° F (43° C)		120° F (49° C)		130° F (55° C)		140° F (60° C)	
°F	°C	Open	Herm	Open	Herm	Open	Herm	Open	Herm	Open	Herm	Open	Herm
-30	-34	1.37	1.57	1.42	1.62	1.47	1.68	*	*	*	*	*	*
-20	-29	1.33	1.49	1.37	1.53	1.42	1.58	1.47	1.65	*	*	*	*
-10	-23	1.28	1.42	1.32	1.46	1.37	1.50	1.42	1.57	1.47	1.64	*	*
0	-18	1.24	1.36	1.28	1.40	1.32	1.44	1.37	1.50	1.41	1.56	1.47	1.62
10	-12	1.21	1.31	1.24	1.34	1.28	1.38	1.32	1.43	1.36	1.49	1.42	1.55
20	- 7	1.17	1.26	1.20	1.29	1.24	1.33	1.28	1.37	1.32	1.43	1.37	1.49
30	- 1	1.14	1.22	1.17	1.25	1.20	1.28	1.24	1.32	1.27	1.37	1.32	1.42
40	4	1.12	1.18	1.15	1.21	1.17	1.24	1.20	1.27	1.23	1.31	1.28	1.35
50	10	1.09	1.14	1.12	1.17	1.14	1.20	1.17	1.23	1.20	1.26	1.24	1.29

Notes:

* Outside normal limits of single stage compressor applications.
For two stage applications use formulae shown above.



Double Risers

A double riser gives the effect of a downsized riser at minimum load, while providing about the same pressure drop as a full sized line at full load. The smaller riser is sized to insure oil return at the minimum capacity step; the larger riser is sized so that the combined “flow areas” of both of these risers are approximately equal to the main suction or discharge line.

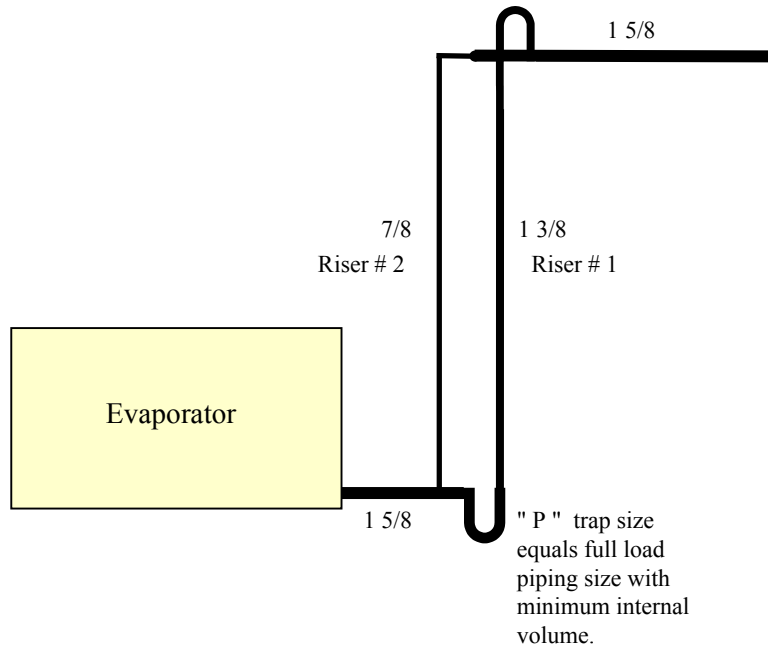

Full load capacity

OD	area
7/8	(0.48)
1 1/8	(0.83)
1 3/8	(1.26)
1 5/8	(1.78)
2 1/8	(3.10)
2 5/8	(4.77)
3 1/8	(6.81)

Minimum capacity ≥ 33 %

Riser #1	&	Riser #2	area
3/4	&	1/2	(0.49)
7/8	&	3/4	(0.83)
1 1/8	&	7/8	(1.31)
1 3/8	&	7/8	(1.74)
1 5/8	&	1 3/8	(3.04)
2 1/8	&	1 5/8	(4.88)
2 5/8	&	1 5/8	(6.55)

Notes:

- * Systems that have capacity control between 33 % and 100 % of their rated capacity can maintain a minimum refrigerant velocity of 1500 fpm in vertical risers by using the above refrigerant double riser selection table.
- * All tubing sizes stated are nominal outside diameter (OD), type “L” copper.
- * Area refers to cross sectional tubing area expressed in square inches.
- * Suggested maximum riser height is 20 ft. for refrigeration applications, 25 to 30 ft. increments for air conditioning applications. As the saturated suction temperature goes down, riser lengths also get shorter.



Double Riser Examples

Example # 1.

Refrigerant: R-404A or R-507
 SST minus 20° F
 SCT 100° F
 Design load 7.5 tons
 Minimum load ... N/A
 Piping runs:
 evaporator to compressor = 50 ft
 compressor to condenser = 30 ft
 condenser to receiver = 30 ft
 receiver to evaporator = 50 ft

Piping runs:

evaporator to compressor = 2 1/8
 evaporator riser ... N/A
 compressor to condenser = 1 1/8
 compressor riser ... N/A
 condenser to receiver = 3/4
 receiver to evaporator = 5/8

Example # 2.

Refrigerant: R-134a
 SST plus 35° F
 SCT 100° F
 Design load 5 tons
 Minimum load 2/3 design
 Piping runs:
 evaporator to compressor = 50 ft
 compressor to condenser = 30 ft
 condenser to receiver = 30 ft
 receiver to evaporator = 50 ft

Piping runs:

evaporator to compressor = 1 3/8
 evaporator riser = 1 1/8 + 7/8
 compressor to condenser = 7/8
 compressor riser ... N/A
 condenser to receiver = 5/8
 receiver to evaporator = 5/8

Example # 3.

Refrigerant: R-407C
 SST plus 40° F
 SCT 105° F
 Design load 15 tons
 Minimum load 50/50 of design
 Piping runs: .. condenser located above
 evaporator to compressor = 25 ft
 compressor to condenser = 20 ft
 condenser to receiver ... no receiver
 condenser to evaporator = 45 ft

Piping runs:

evaporator to compressor = 1 5/8
 evaporator riser = 1 3/8 + 7/8
 compressor to condenser = 1 1/8
 compressor riser = 7/8 + 3/4
 condenser to receiver ... no receiver
 receiver to evaporator = 3/4

Notes:

SST is Saturated Suction Temperature
 SCT is Saturated Condensing Temperature
 N/A is Not Applicable

Notes:

1 psi will support 1.8 ft typical refrigerant
 1 psi will support 2.3 ft H₂O
 1 psi will support 2.5 ft typical oil

Typical Condenser Piping Arrangements

Condensers above compressor and receiver

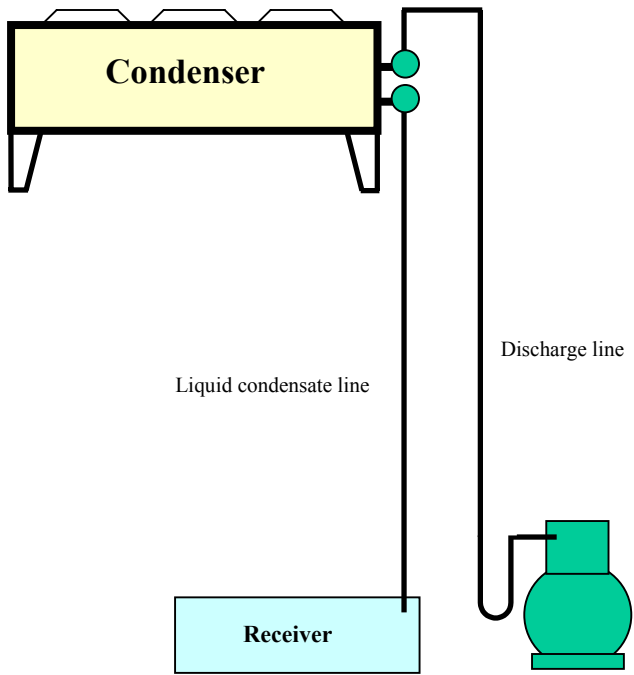

Single Riser

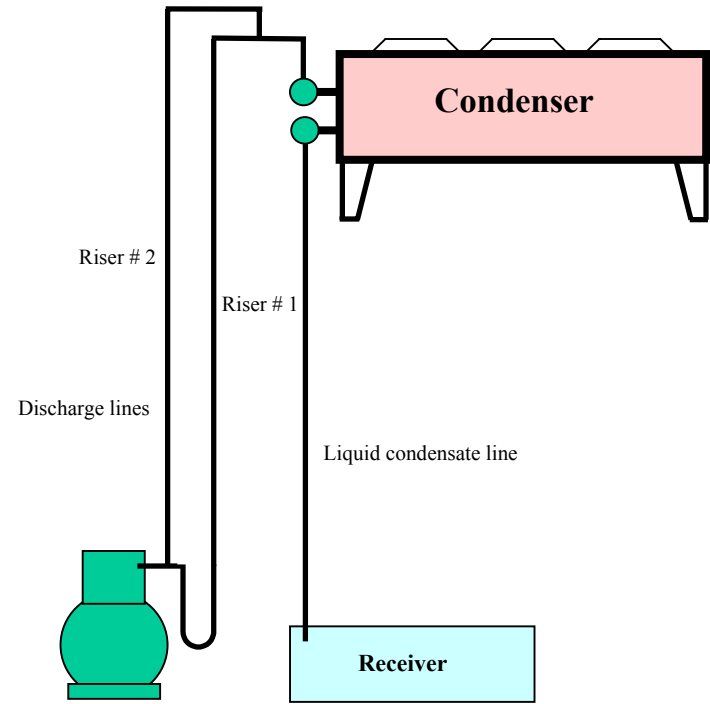

Double Riser

Typical Condenser Piping Arrangements

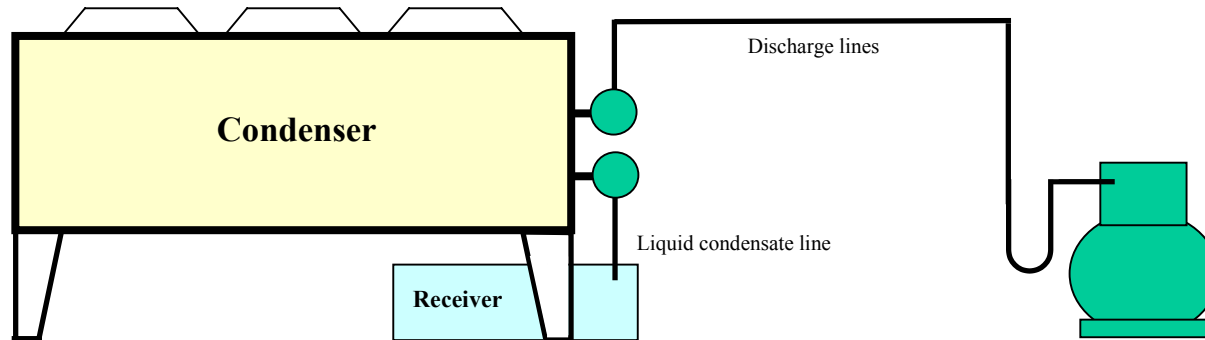

Equipment on Same Level

Typical Liquid Condensate Piping

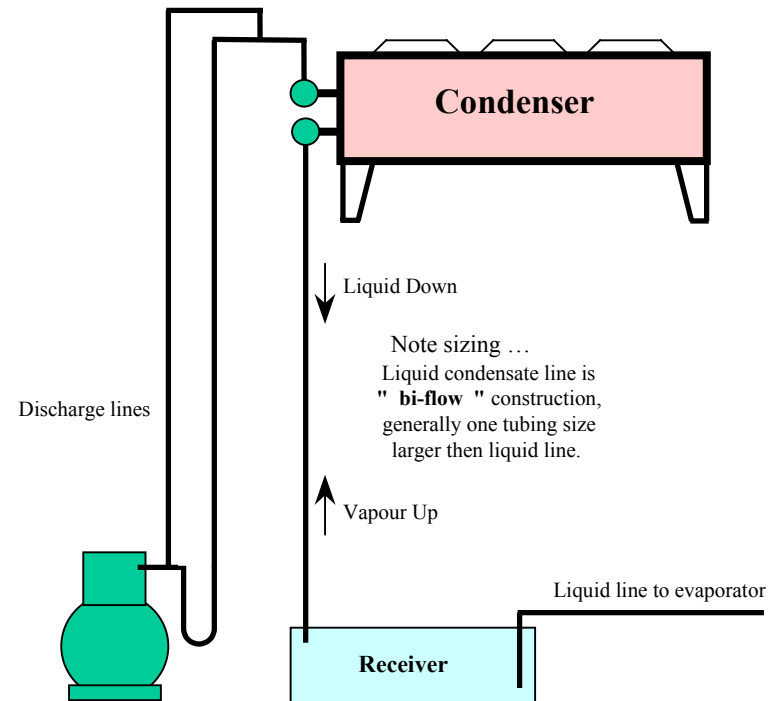

Typical Hot Gas Binding Line

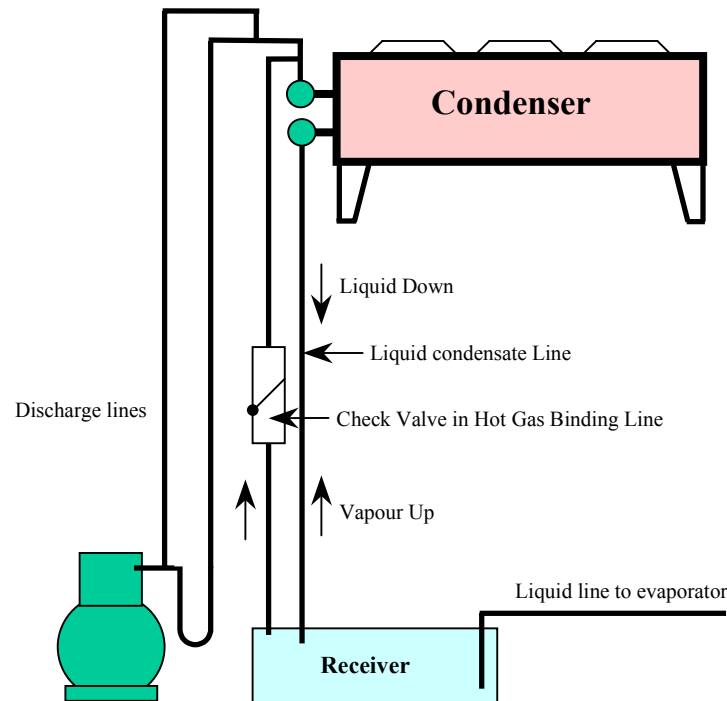

Notes:

This Hot Gas Binding line is needed on installations using an evaporative condenser or on air cooled condensers where the receiver is located where it can become warmer than the condenser. For example having the condenser on the roof and its receiver located on an inside mezzanine below the condenser.



Typical Effects of Height on Pressure

Vapour riser / drop

Liquid riser / drop

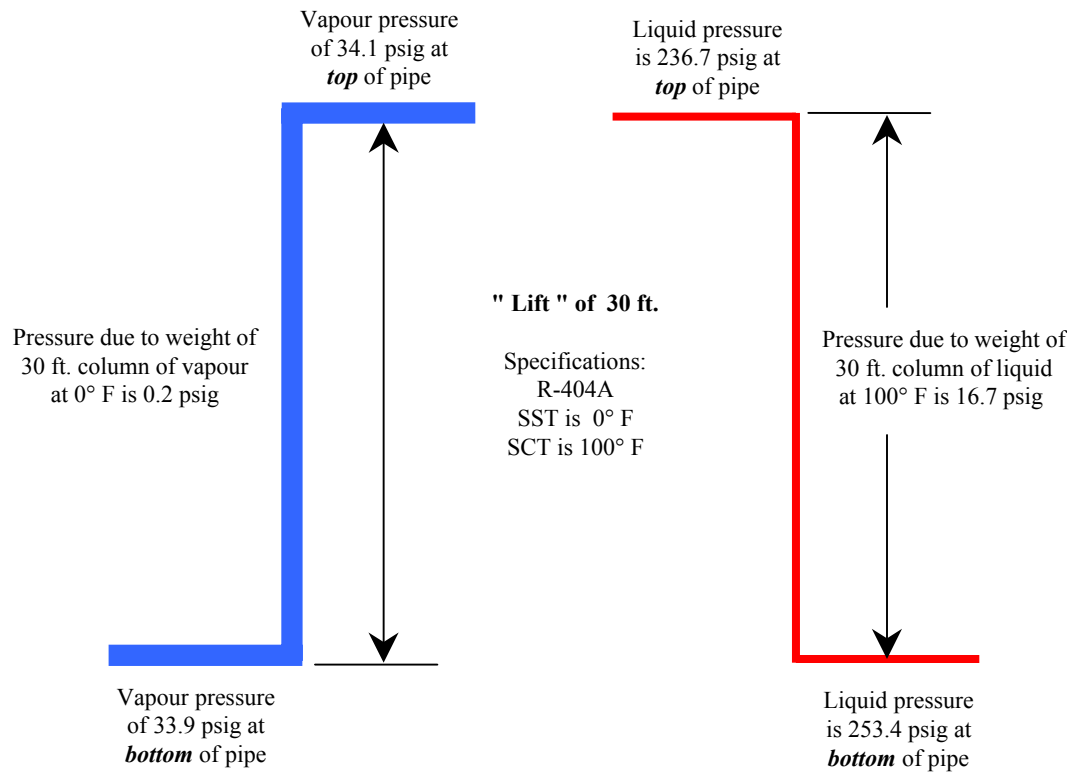

A factor affecting liquid lines is the effect of a change in height or elevation. This factor is usually of negligible importance in vapour lines where the weight of the fluid is low enough so that it has minimal impact on the total pressure of a column of vapour. In liquid line, though, the fluid is quite dense. The weight of the liquid produces a significant change in the pressure from the top to the bottom of the column of fluid. Fluorocarbon refrigerant, typically, produces about 1 pound change in pressure for every 1.8 feet of liquid height. Where the flow proceeds from a higher level to a lower level, the weight of the liquid column adds to the refrigerant pressure at the end of the line, therefore increases the ΔP across the expansion device. However, where the flow proceeds from a lower level to a higher level, pressure is lost, thereby resulting in the flashing of liquid refrigerant in the liquid line.

Notes:

- 1 psi will support 1.8 ft typical refrigerant
- 1 psi will support 2.3 ft H₂O
- 1 psi will support 2.5 ft typical oil



Recommendation for Pipe Hanger Spacing

Maximum Spacing Between Pipe Supports for Copper Tubing

Nominal (OD) Diameter	<u>Max.</u> Span in Ft.
5/8	5
7/8	6
1 1/8	7
1 3/8	8
1 5/8	9
2 1/8	10
2 5/8	11
3 1/8	12
3 5/8	13
4 1/8	14

1967 ASHRAE Guide and Data Book

① Maximum allowable hanger distance as per CSA B52 code



The miracles of science™

Expansion / Contraction

Section 5



Refrigerant Piping Expansion and Contraction



Expansion / Contraction ... Section Five

Expansion / Contraction page 3



Refrigerant Piping Expansion and Contraction

All refrigeration piping materials are subject to changes in temperature and will expand and contract with temperature change. Installation techniques must allow for expansion and contraction changes, this will prevent stresses which may buckle and rupture the copper tube or joints.

The average coefficient of expansion of copper is 0.0000104 inch/per inch/per degree F. Copper tubing will expand about 1 1/4 inches per 100 feet per 100F° change in temperature. For example a copper line 75 feet long is used to carry hot discharge refrigerant vapour at 225° F to the systems condenser. The change in temperature could be 155F°, that is 225 - 70 (room ambient). The expected expansion on this application could very well be $75 \times 12 \times 0.0000104 \times 155 = 1.451$ or 1.5 inches.

There are two common methods of taking care of expansion and contraction in copper lines used in the refrigeration industry. These are the use of “expansion loops” or “pipe offsets”. See figures 1 and 2 for specifics on these two methods.

In the installation of expansion loops, the expansion member should be “cold sprung” approximately one-half the estimated travel expected. In this manner the bend is subject to only about one-half of the stress when the line is at the highest temperature, than it would be if the loop were installed in its natural position.

Care must be taken during the installation of the lines to maintain perfect alignment, if not, there will be a tendency for the lines to bow, and possibly buckle or rupture, particularly on the smaller sizes.

Continued



Refrigerant Piping Expansion and Contraction

Continued

It is often possible to provide for expansion by offsetting the pipe line rather than to continue in a straight line. This method can be used only where there is plenty of space available. A single offset using two 90° elbows should have a minimum length of not less than three times the radius required in an expansion loop. The legs of the offset should not be spaced less than two times the radius from each other, see figure 2. This method is just as effective as expansion loops and can be made on the job, see table 1 for fabrication details. Offsetting by means of long radius allows the installer to vary the length to suit the job. Due to the amount of labour involved in the fabrication of expansion loops they are considered more expensive than offsets made up on the job.

So far we have referred only to main lines in general; these are usually thought of as horizontal. Vertical lines or risers must also be considered in the same manner. Risers should have adequate support at or near the bottom. Where branch lines to fixtures are taken off they should be sufficiently long to take care of any movement in the main.

Rigid fixtures should never be directly connected to risers. One or two turns or elbows in the line will take care of the short branches. Copper tubing may not break as readily, but if continually subjected to strain and bending it will ultimately fail. Designers and contractors must always keep the matter of expansion and contraction in mind.

Continued

Refrigerant Piping Expansion and Contraction

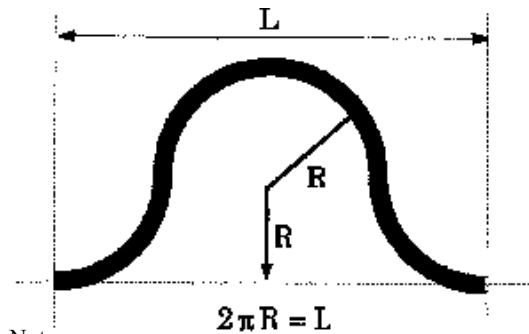

Note:

1. All radii are referenced to the centre line of pipe.
2. "L" length of pipe is referenced to the total length measured along the centre line of the bent pipe.

Figure 1: Expansion Loop (U-Bend)

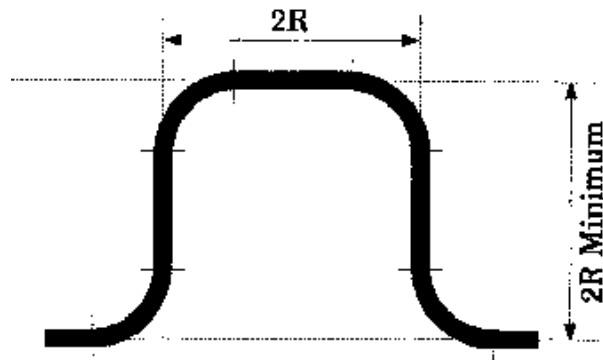

Offset with four (4) 90° LR elbows

Figure 2: Offset and Return

A freezer operating at a SST of minus 30° F and 100ft from the mechanical room which is 70° F, the compressor discharge temperature is 225° F and the condenser 75ft away.

Suction "shrinkage" is $0.0000104 \times 12 \times 100 \times 100 = 1.248$ or 1 1/4 inches.

Discharge expansion is $0.0000104 \times 12 \times 75 \times 155 = 1.451$ or 1 1/2 inches.

Total expansion and contraction movement in this freezer application would be $1 \frac{1}{4} + 1 \frac{1}{2} = 2 \frac{3}{4}$ inches. The installation and servicing contractor must be aware of the potential problems that could arise if these factors are not taken into consideration in the original installation.

Note example .. Suction .. $0.0000104 / \text{inch} \times 12" \times 100 \text{ ft} \times \Delta 100^\circ \text{ F} = 1.248$ inches

Table 1

Tube OD	Radius - R - inch							
	For travel of ...	1/2 "	1 "	1 1/2 "	2 "	2 1/2 "	3 "	4 "
7/8	10	15	19	22	25	27	30	
1 1/8	11	16	20	24	27	29	33	
1 3/8	11	17	21	26	29	32	36	
1 5/8	12	18	23	28	31	35	-----	
2 1/8	14	20	25	31	34	-----	-----	
2 5/8	16	22	27	32	-----	-----	-----	
3 1/8	18	24	30	34	-----	-----	-----	
4 1/8	20	28	34	-----	-----	-----	-----	

Bends can be made from 20 feet or less of tubing

Note: bracket supports should be within six inches of a change of direction and opposite the source of vibration.



The miracles of science™

Best Practices

Section 6



Best Piping Practices



Best Piping Practices ... Section Six

Liquid Line for Multi-case	page 3
Split A/C system	page 6
Multi-Evaporators Hot Gas	page 9
Liquid Line Stacked Evaporators	page 12
Multi-Circuited Condenser	page 15



Refrigerant Piping Practices

Liquid Line Piping for Multi-case Hot Gas Defrost

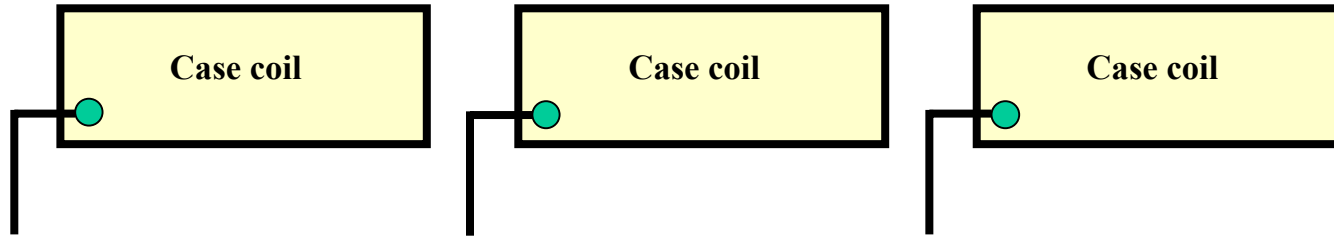

A

Liquid Line

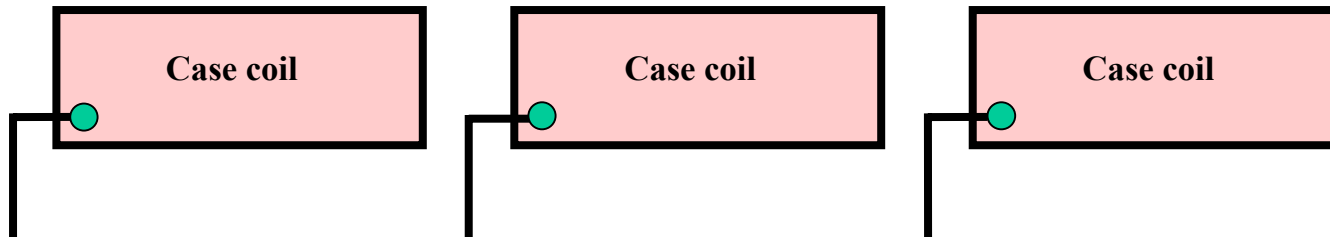

B

Liquid Line

 Denotes TXV

Continued



Refrigerant Piping Practices

Liquid Line Piping for Multi-case Hot Gas Defrost

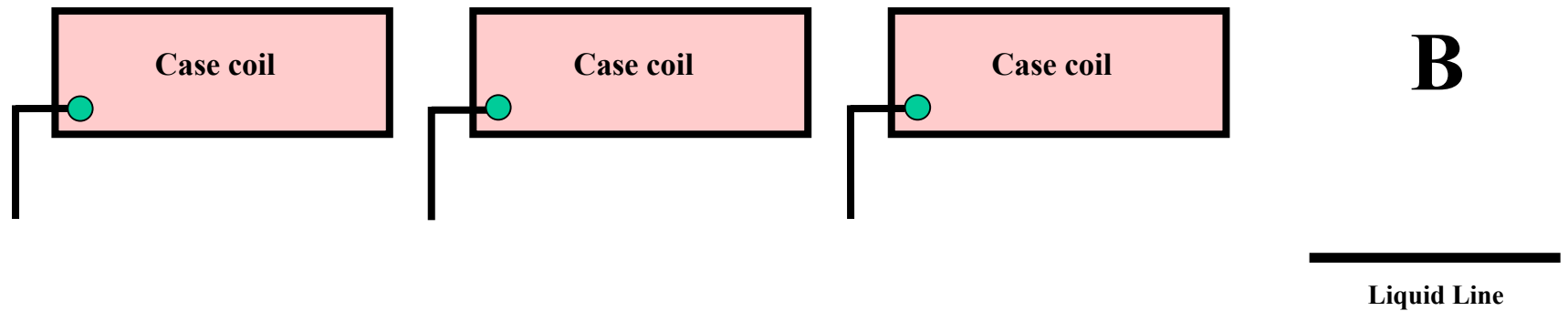
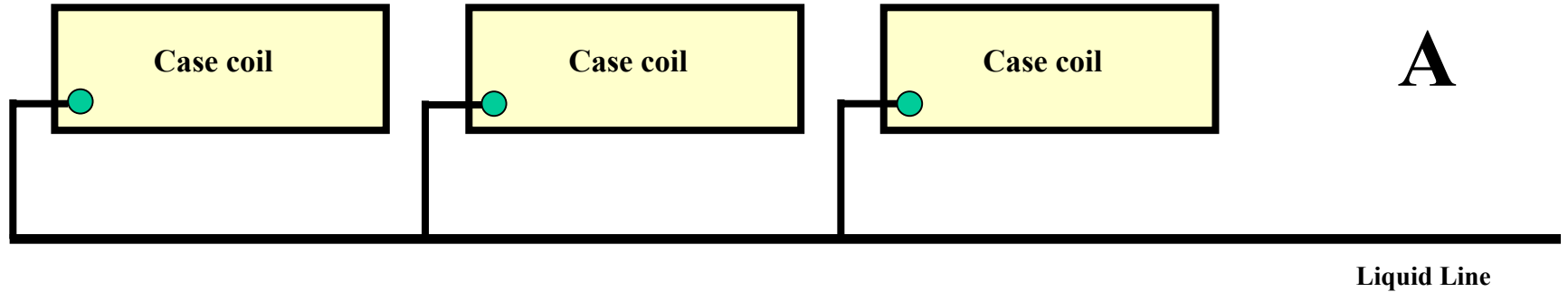

 Denotes TXV

Continued

Refrigerant Piping Practices

Liquid Line Piping for Multi-case Hot Gas Defrost

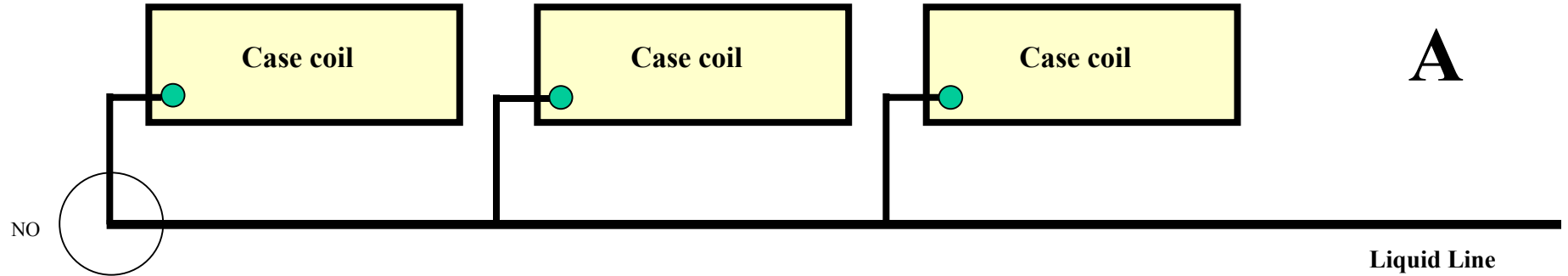

“A” is not recommended because of liquid hammer also expansion and contraction will “work” the elbow and cause a failure.

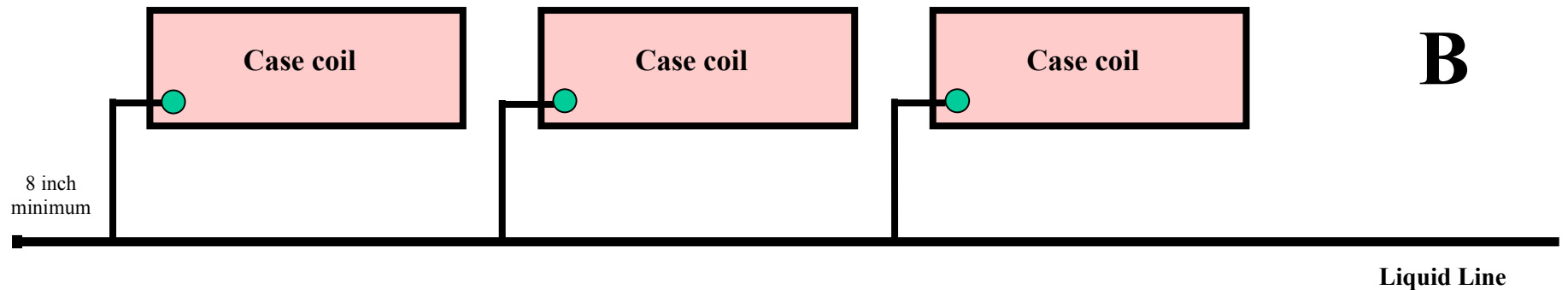

“B” is recommended because liquid hammer will not effect the fittings also expansion and contraction will take place on liquid header not the branch fittings.

Denotes TXV



Refrigerant Piping Practices

Split A/C system, 100 ft apart, evaporator above condensing unit

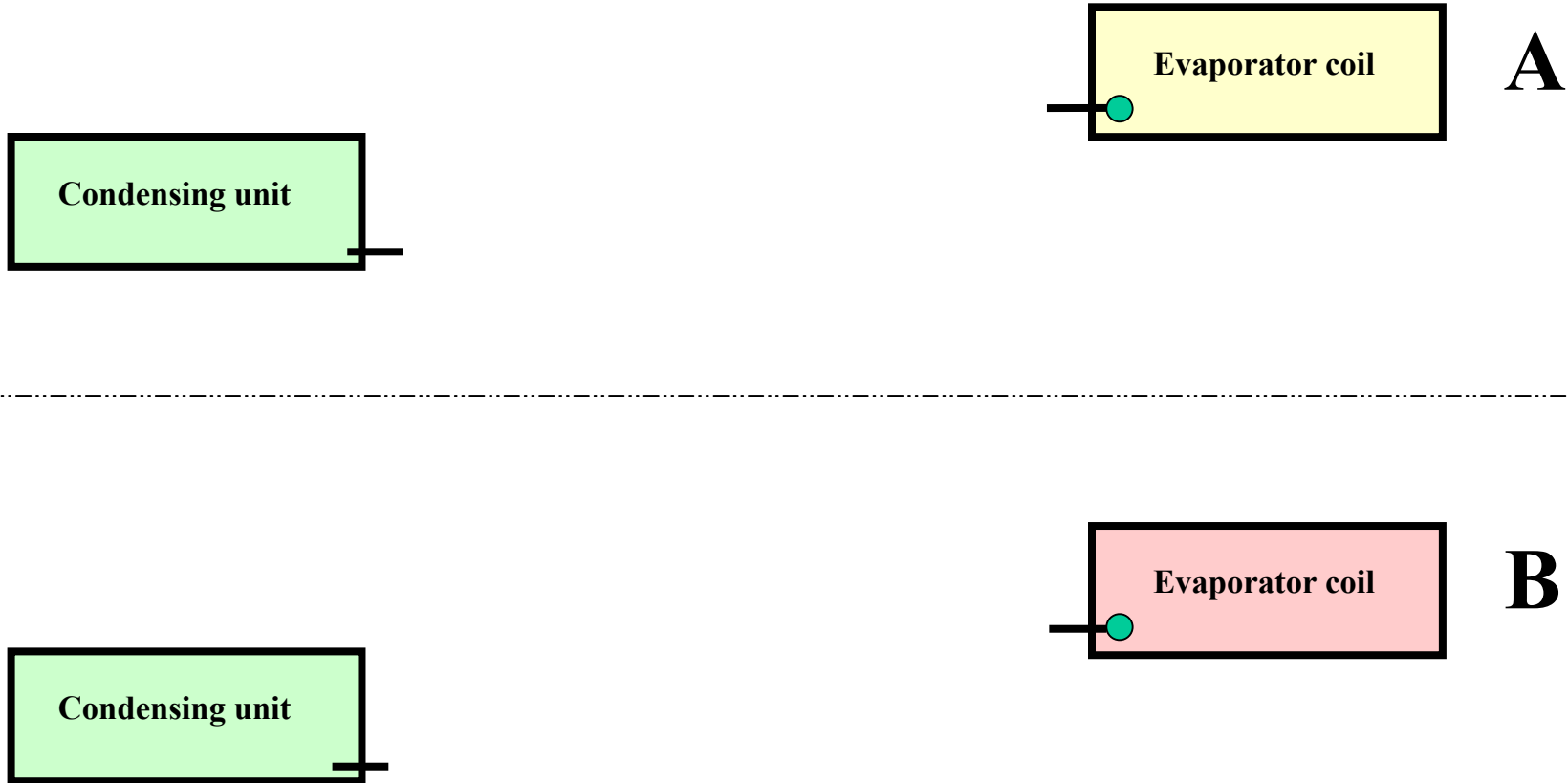

 Denotes TXV

Continued



Refrigerant Piping Practices

Split A/C system, 100 ft apart, evaporator above condensing unit

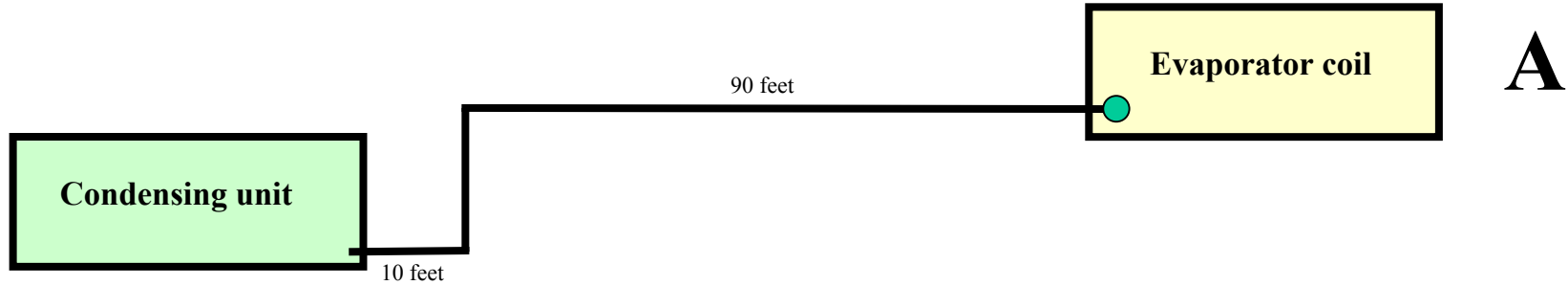

 Denotes TXV

Continued



Refrigerant Piping Practices

Split A/C system, 100 ft apart, evaporator above condensing unit

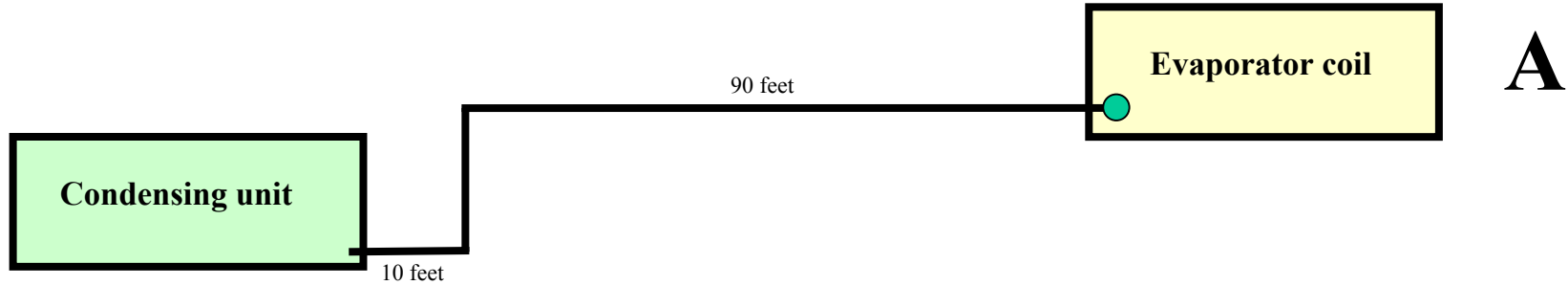

Note: 100 feet of 7/8 tubing will hold 25 pounds of liquid R-22 refrigerant.

“A” is not recommended because 90 ft of liquid refrigerant (90 % of 25 = 22.5 lbs) will drain on off cycle into condensing unit, damage compressor on start-up.

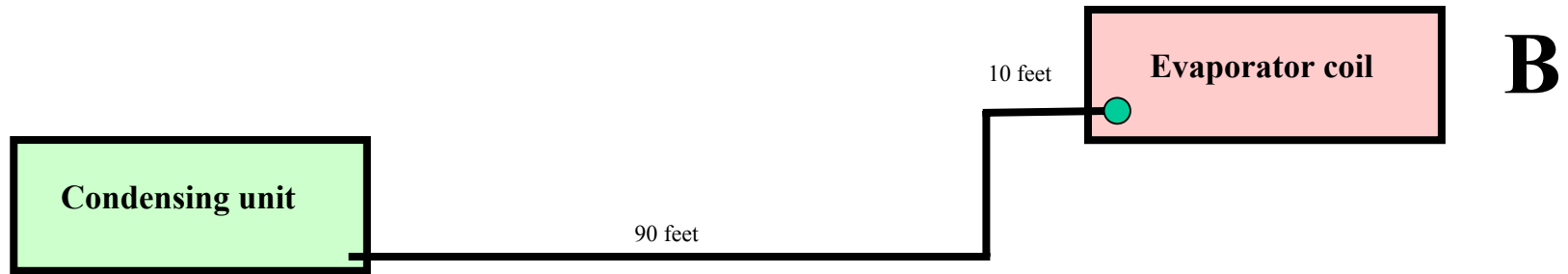

Note: 100 feet of 7/8 tubing will hold 25 pounds of liquid R-22 refrigerant.

“B” is recommended because only 10 ft of liquid refrigerant (10 % of 25 = 2.5 lbs) will drain on off cycle into condensing unit, less chance of damage on start-up.

 Denotes TXV



Refrigerant Piping Practices

Same Circuit Multi Evaporators with Hot Gas Defrost

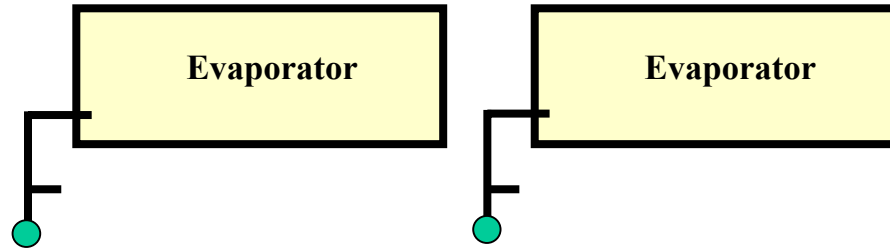

A

Hot Gas Defrost Line

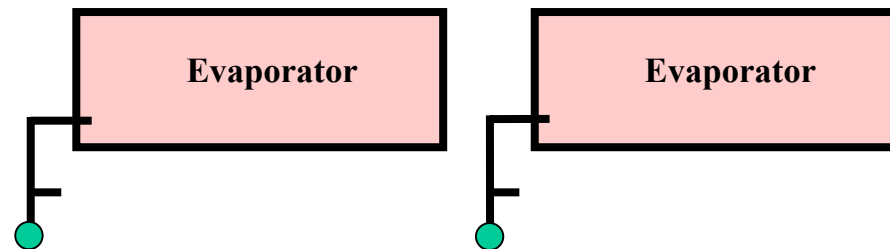

B

Hot Gas Defrost Line

 Denotes TXV

Continued



Refrigerant Piping Practices

Same Circuit Multi Evaporators with Hot Gas Defrost

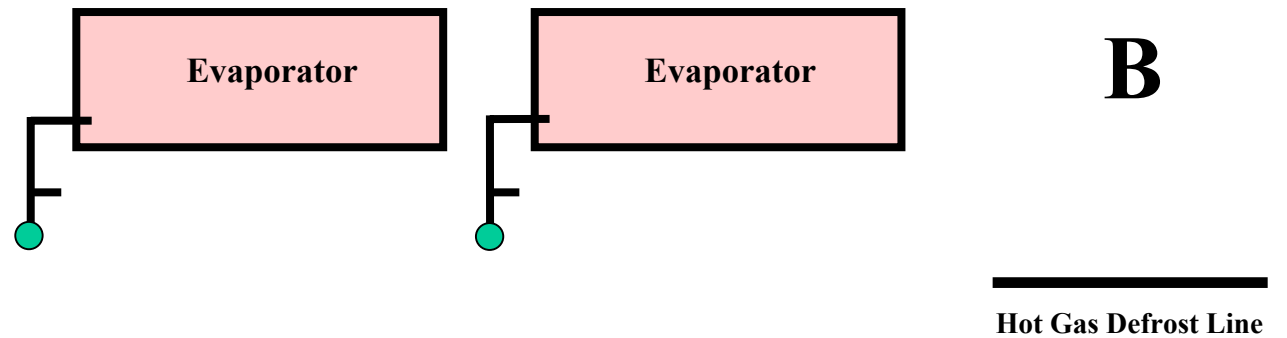
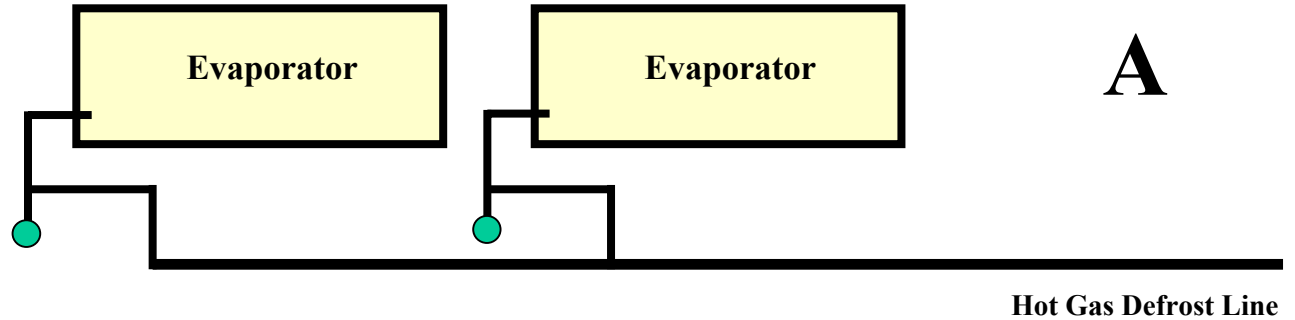

 Denotes TXV

Continued



Refrigerant Piping Practices

Same Circuit Multi Evaporators with Hot Gas Defrost

“A” is not recommended because when the ‘Hot Gas’ is off liquid refrigerant can be feed from one evaporator to the other evaporator.

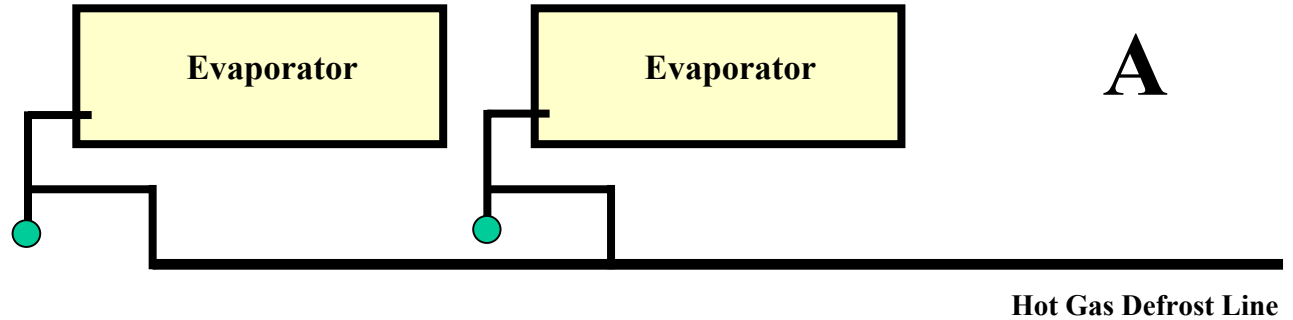

“B” is recommended because there is a check valve in the Hot Gas line leading to the side inlet “Tee”. Thereby preventing liquid refrigerant from entering the other evaporator when Hot Gas defrost is not in use.

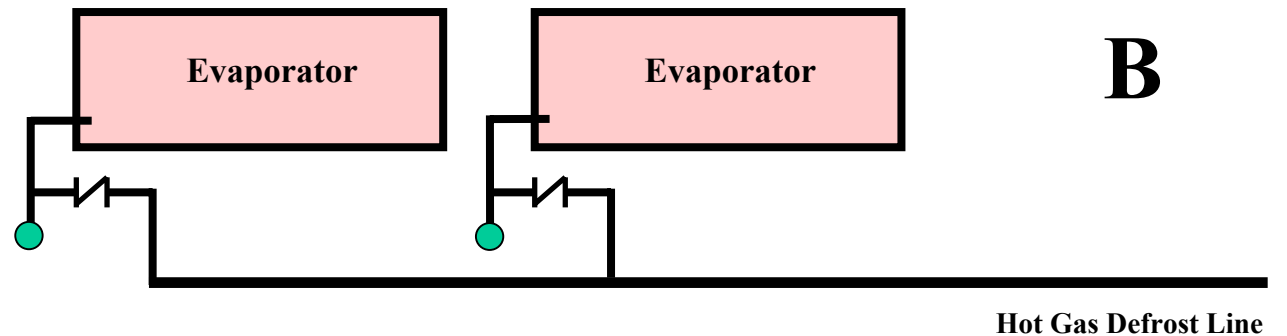

 Denotes TXV



Refrigerant Piping Practices

A

Liquid Line Feed to Stacked Evaporator Coils

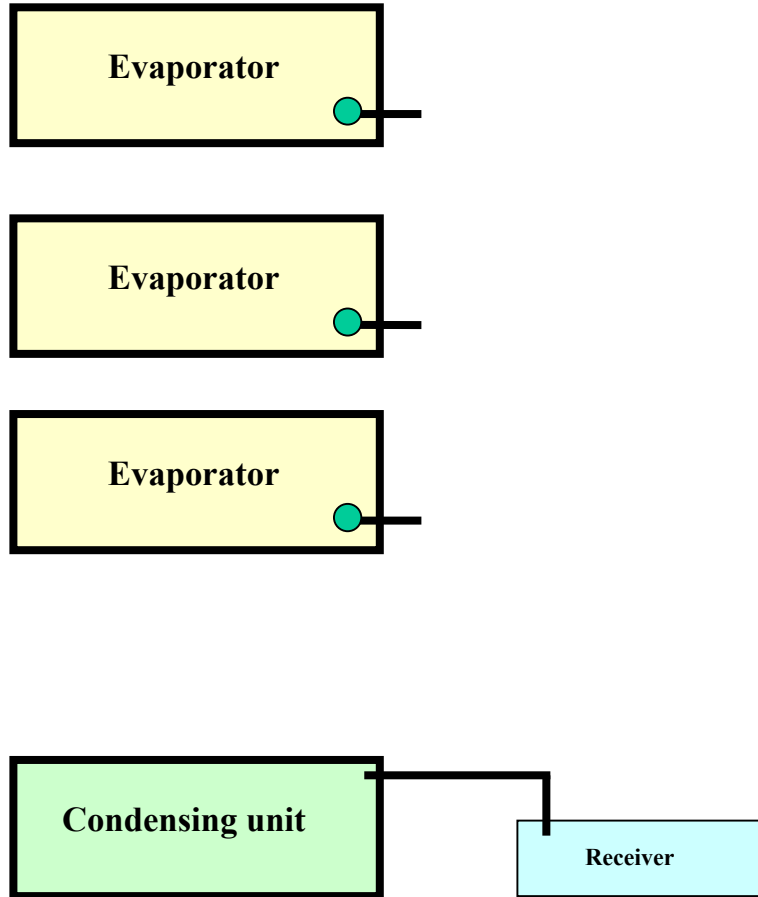

B

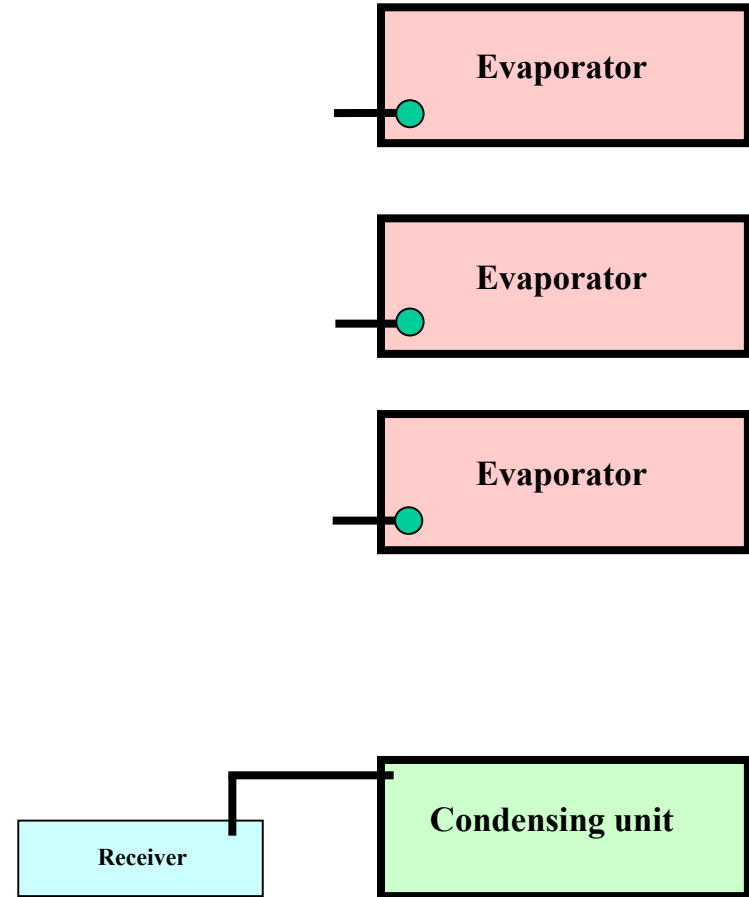

● Denotes TXV

Continued



Refrigerant Piping Practices

A

Liquid Line Feed to Stacked Evaporator Coils

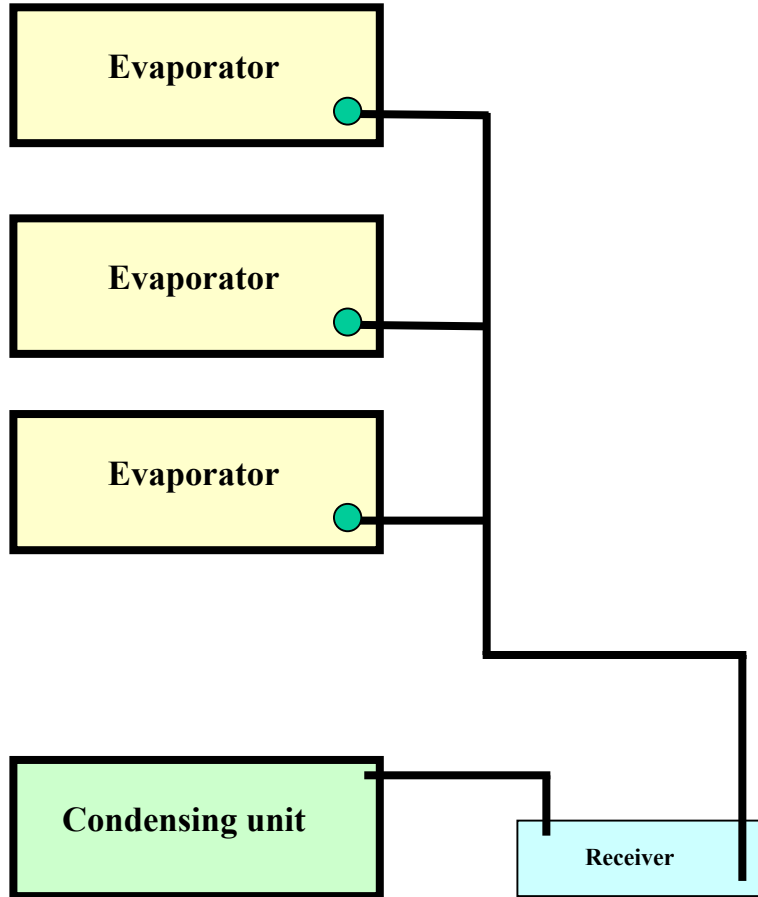

B

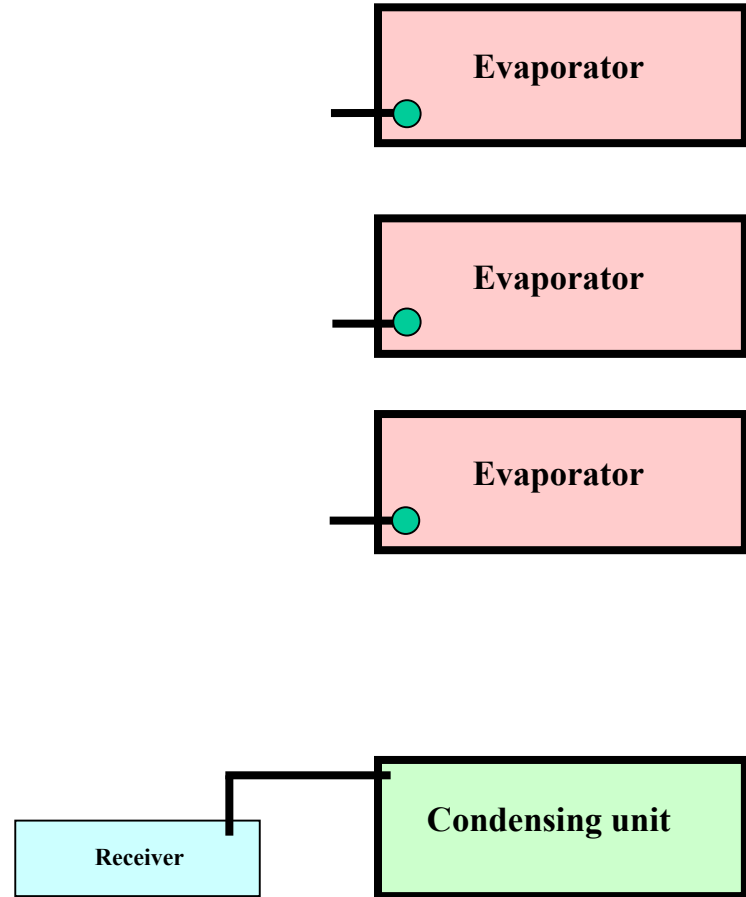

● Denotes TXV

Continued

Refrigerant Piping Practices

Liquid Line Feed to Stacked Evaporator Coils

A

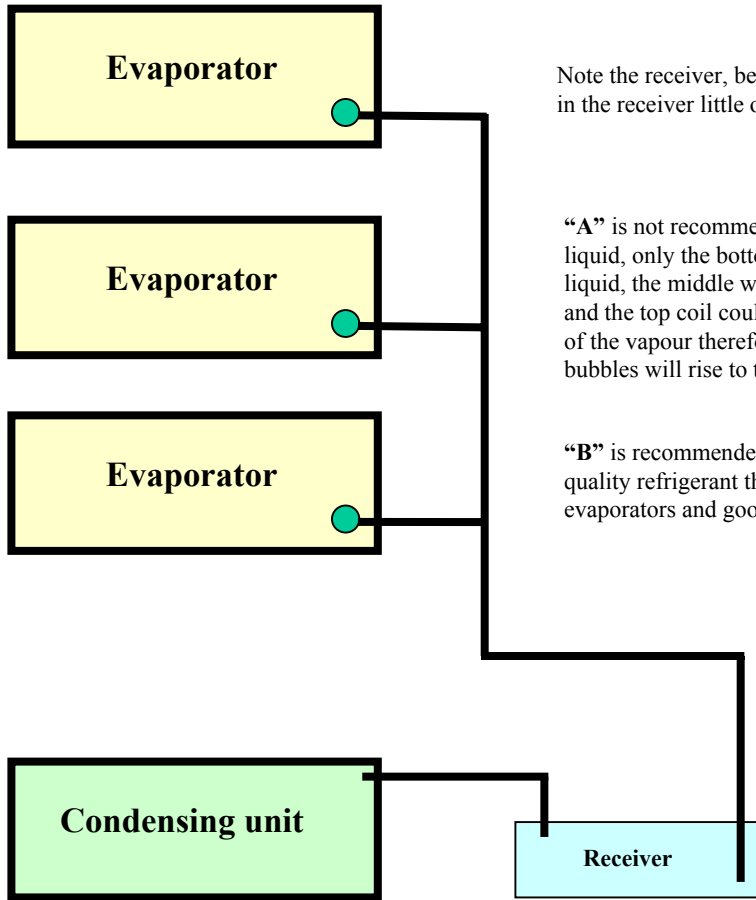

Note the receiver, because there is a two phase condition in the receiver little or not sub-cooling is available.

“A” is not recommended because of the “static head” of liquid, only the bottom coil will receive a full column of liquid, the middle would have liquid and some vapour and the top coil could receive little liquid and the majority of the vapour therefore poor system performance. Vapour bubbles will rise to the top coil.

“B” is recommended as all coils will be feed equal quality refrigerant therefore having balanced evaporators and good performance.

B

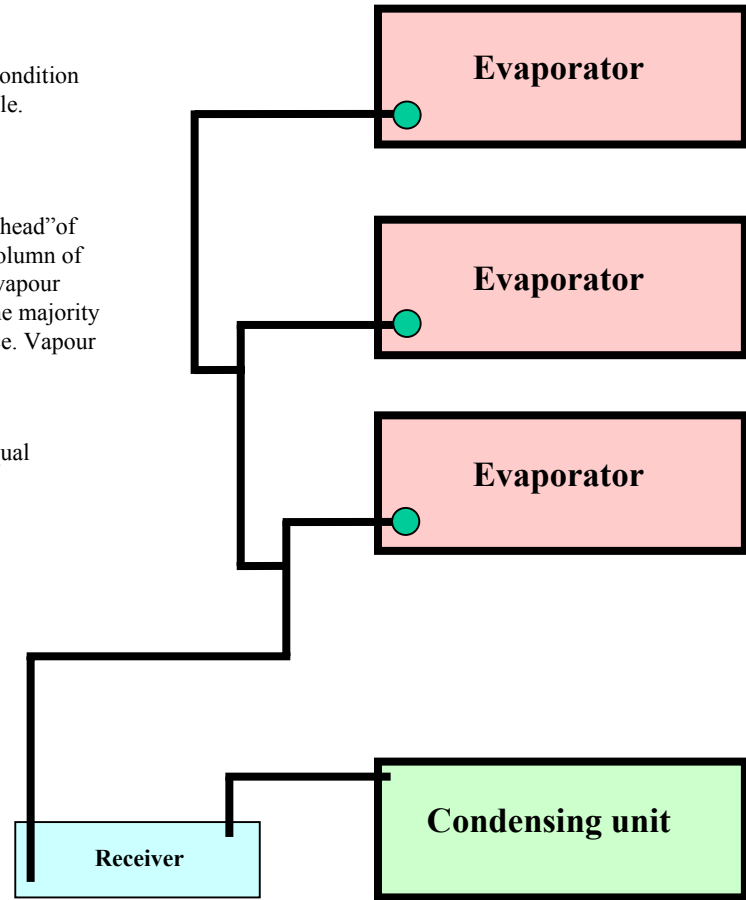

Denotes TXV

Typical Condenser Piping Arrangements

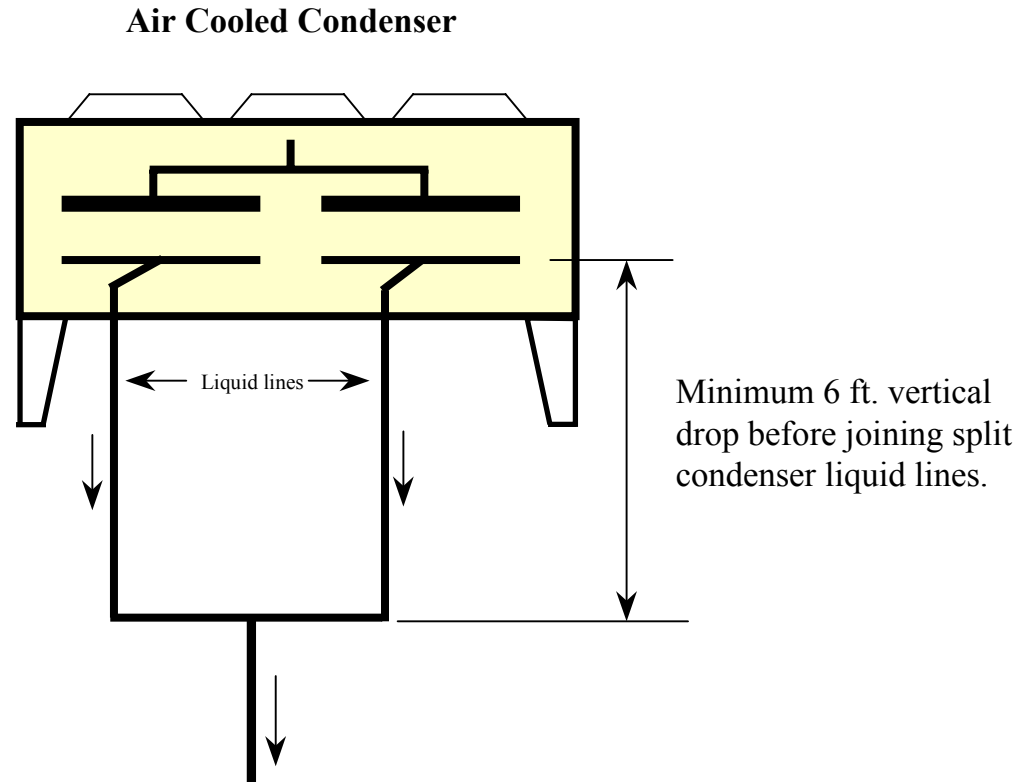

Split Condenser Circuits



The miracles of science™

" Quick Pick " Criteria

Section 7



The miracles of science™

Suva[®]
refrigerants

Refrigerant Piping

" Quick Pick "

Selection Criteria

The Quick Pick Manual is designed around the use of ACR tubing. This quick reference is for tonnages up to 50 tons in capacity and having a maximum total equivalent line length not exceeding 150 feet. These tables are based on a minimum velocity of 1500 fpm. For larger tonnages, verification of velocities, verification of pressure drops or line sizes please use the appreciate nomograph.



Refrigerant Piping

“Quick Pick” Criteria

Good piping design will result in a system having large enough discharge, liquid and suction lines to prevent excessive pressure drop yet be small enough to maintain an adequate velocity of refrigerant flow to return the oil to the compressor crankcase.

Refrigerant Line Velocities

1. Liquid condensate line from the condensers to receivers should be sized for a velocity of 100 fpm or less.
2. Liquid lines from the receiver to evaporators should be sized to maintain a velocity below 300 fpm to minimizing liquid hammer.
3. Vapour line feasible design velocities^① are:
 - Suction line 900 to 4000 ft/min
 - Discharge line ... 2000 to 3500 ft/min
 - Defrost line 1000 to 2000 ft/min
4. A double riser gives the effect of a downsized riser at minimum load, while providing about the same pressure drop as a full sized line at full load. The smaller riser is sized to ensure oil return at the minimum capacity step; the larger riser is sized so that the combined “flow areas” of both of these risers is approximately equal to that of the main suction line.

① Velocities as recommended by ASHRAE Fundamentals handbook

* The following Refrigerant “Quick Pick” tables are based on a minimum refrigerant velocity of at least 1500 ft/min while not exceeding the suggested allowable pressure drop in psig equaling 2F° in the suction lines. The discharge line and the liquid line are based on a pressure drop maximum equaling 1F° .



The miracles of science™

HFC "Quick Pick"

Section 8



The miracles of science™

Suva®
refrigerants

Suva® HFC Refrigerant

" Quick Pick "

Handbook



HFC " Quick Pick " ... Section Eight

HFC Replacement Guide	page 3
R-134a Quick Pick	page 4
R-404A Quick Pick	page 10
R-407C Quick Pick	page 16
R-410A Quick Pick	page 22
R-507 Quick Pick	page 26
R-508B Quick Pick	page 34



HFC Replacement Guide

Direct Expansion Applications

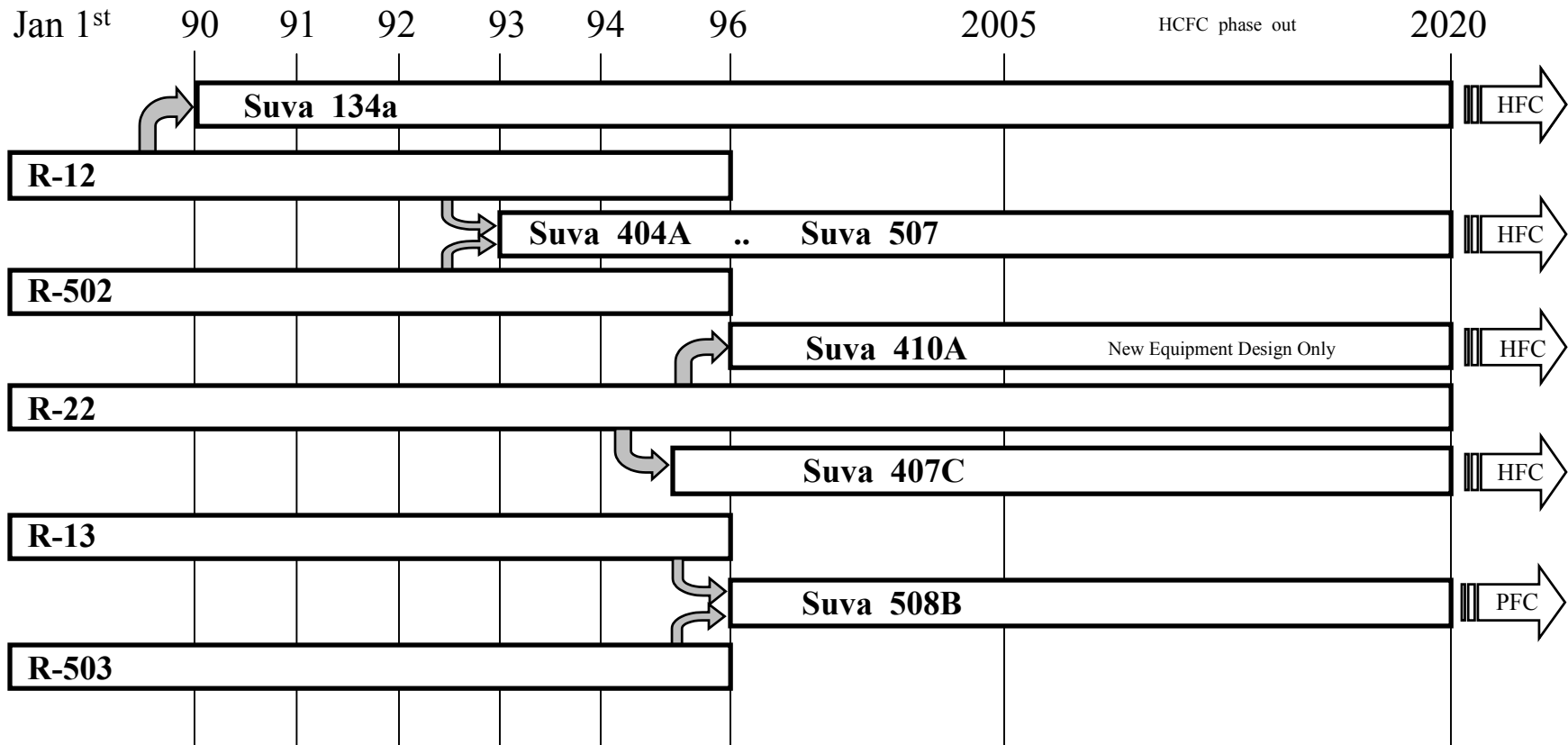

Guide Notes: _____



The miracles of science™

Suva[®]
refrigerants

Refrigerant

Suva 134a (R-134a)

Piping Guide

From 18,000 BTU through 600,000 BTU per hour at -30° F through + 50° F saturated suction temperature. (1.5 ton through 50.0 tons)

" Quick Pick "



Suva 134a Refrigerant Piping Guide



Suction Line Size .. Evaporator to Compressor

		50° F through 30° F (48 through 26 psig)					29° F through 10° F (25 through 12 psig)					9° F through -10° F (11 through 2 psig)						
		Suggested Allowable Pressure Drop in psig = 2F°																
		2.2 lbs. (2F°)					1.4 lbs. (2F°)					1.0 lbs. (2F°)						
System Capacity BTU/Hr.	System Capacity Tons/Hr	Equivalent Suction Line Lengths ... feet															System Capacity Tons/Hr	System Capacity BTU/Hr.
		25	50	75	100	150	25	50	75	100	150	25	50	75	100	150		
18,000	1.50	5/8	3/4	3/4	7/8	7/8	3/4	7/8	1 1/8	1 1/8	1 1/8	7/8	1 1/8	1 1/8	1 1/8	1 3/8	1.50	18,000
24,000	2.00	3/4	7/8	7/8	7/8	1 1/8	7/8	1 1/8	1 1/8	1 1/8	1 1/8	1 1/8	1 1/8	1 1/8	1 3/8	1 3/8	2.00	24,000
30,000	2.50	3/4	7/8	1 1/8	1 1/8	1 1/8	7/8	1 1/8	1 1/8	1 1/8	1 3/8	1 1/8	1 3/8	1 3/8	1 3/8	1 5/8	2.50	30,000
36,000	3.00	3/4	7/8	1 1/8	1 1/8	1 1/8	1 1/8	1 1/8	1 1/8	1 3/8	1 3/8	1 1/8	1 3/8	1 3/8	1 5/8	1 5/8	3.00	36,000
42,000	3.50	7/8	1 1/8	1 1/8	1 1/8	1 3/8	1 1/8	1 1/8	1 3/8	1 3/8	1 3/8	1 3/8	1 3/8	1 3/8	1 5/8	1 5/8	3.50	42,000
48,000	4.00	7/8	1 1/8	1 1/8	1 1/8	1 3/8	1 1/8	1 3/8	1 3/8	1 3/8	1 5/8	1 3/8	1 3/8	1 5/8	1 5/8	2 1/8	4.00	48,000
60,000	5.00	1 1/8	1 1/8	1 3/8	1 3/8	1 3/8	1 1/8	1 3/8	1 3/8	1 5/8	1 5/8	1 3/8	1 5/8	1 5/8	2 1/8	2 1/8	5.00	60,000
92,000	7.50	1 1/8	1 3/8	1 3/8	1 5/8	1 5/8	1 3/8	1 5/8	1 5/8	2 1/8	2 1/8	1 5/8	2 1/8	2 1/8	2 1/8	2 1/8	7.50	92,000
120,000	10.00	1 3/8	1 3/8	1 5/8	1 5/8	2 1/8	1 5/8	1 5/8	2 1/8	2 1/8	2 1/8	1 5/8	2 1/8	2 1/8	2 5/8	2 5/8	10.00	120,000
150,000	12.50	1 3/8	1 5/8	1 5/8	2 1/8	2 1/8	1 5/8	2 1/8	2 1/8	2 1/8	2 5/8	2 1/8	2 1/8	2 5/8	2 5/8	2 5/8	12.50	150,000
180,000	15.00	1 5/8	1 5/8	2 1/8	2 1/8	2 1/8	2 1/8	2 1/8	2 1/8	2 5/8	2 5/8	2 1/8	2 5/8	2 5/8	2 5/8	3 1/8	15.00	180,000
240,000	20.00	1 5/8	2 1/8	2 1/8	2 1/8	2 5/8	2 1/8	2 1/8	2 5/8	2 5/8	2 5/8	2 1/8	2 5/8	3 1/8	3 1/8	3 1/8	20.00	240,000
300,000	25.00	1 5/8	2 1/8	2 1/8	2 5/8	2 5/8	2 1/8	2 1/8	2 5/8	2 5/8	3 1/8	2 5/8	3 1/8	3 1/8	3 1/8	3 5/8	25.00	300,000
360,000	30.00	2 1/8	2 1/8	2 5/8	2 5/8	2 5/8	2 1/8	2 5/8	2 5/8	3 1/8	3 1/8	2 5/8	3 1/8	3 1/8	3 5/8	3 5/8	30.00	360,000
420,000	35.00	2 1/8	2 5/8	2 5/8	2 5/8	3 1/8	2 5/8	2 5/8	3 1/8	3 1/8	3 5/8	2 5/8	3 1/8	3 5/8	3 5/8	4 1/8	35.00	420,000
480,000	40.00	2 1/8	2 5/8	2 5/8	2 5/8	3 1/8	2 5/8	3 1/8	3 1/8	3 1/8	3 5/8	3 1/8	3 5/8	3 5/8	3 5/8	4 1/8	40.00	480,000
540,000	45.00	2 1/8	2 5/8	2 5/8	3 1/8	3 1/8	2 5/8	3 1/8	3 1/8	3 5/8	3 5/8	3 1/8	3 5/8	3 5/8	4 1/8	4 1/8	45.00	540,000
600,000	50.00	2 5/8	2 5/8	3 1/8	3 1/8	3 1/8	2 5/8	3 1/8	3 5/8	3 5/8	3 5/8	3 1/8	3 5/8	4 1/8	4 1/8	5 1/8	50.00	600,000

- Refer to DuPont Refrigerant Expert, version 2.0 for actual velocities and pressure drops.
- Equivalent length is actual length plus friction losses caused by fittings and accessories.
- Line sizes are expressed in outside diameter of type “L” copper tubing.
- Line sizes are calculated at rated full load system capacity.
- All selections are based on a maximum of 65° F return gas entering the compressor and a refrigerant condensing and liquid line temperature of 105° F.



Suva 134a Refrigerant Piping Guide



Suction Line Size .. Evaporator to Compressor

		- 11° F through - 30° F (1 psig through 10" Hg)					- 31° F through - 50° F (11" through 19" Hg)						
		Suggested Allowable Pressure Drop in psig = 2F°											
		0.6 lbs. (2F°)					0.5 lbs. (2F°)						
System Capacity BTU/Hr.	System Capacity Tons/Hr	Equivalent Suction Lengths ... feet										System Capacity Tons/Hr	System Capacity BTU/Hr.
		25	50	75	100	150	25	50	75	100	150		
18,000	1.50	1 1/8	1 1/8	1 3/8	1 3/8	1 5/8						1.50	18,000
24,000	2.00	1 3/8	1 3/8	1 3/8	1 5/8	1 5/8						2.00	24,000
30,000	2.50	1 3/8	1 3/8	1 5/8	1 5/8	2 1/8	N/A	N/A	N/A	N/A	N/A	2.50	30,000
36,000	3.00	1 3/8	1 5/8	1 5/8	2 1/8	2 1/8						3.00	36,000
42,000	3.50	1 3/8	1 5/8	2 1/8	2 1/8	2 1/8						3.50	42,000
48,000	4.00	1 5/8	1 5/8	2 1/8	2 1/8	2 1/8						4.00	48,000
60,000	5.00	1 5/8	2 1/8	2 1/8	2 1/8	2 5/8						5.00	60,000
92,000	7.50	2 1/8	2 1/8	2 5/8	2 5/8	2 5/8						7.50	92,000
120,000	10.00	2 1/8	2 5/8	2 5/8	2 5/8	3 1/8	N/A	N/A	N/A	N/A	N/A	10.00	120,000
150,000	12.50	2 5/8	2 5/8	3 1/8	3 1/8	3 1/8						12.50	150,000
180,000	15.00	2 5/8	3 1/8	3 1/8	3 1/8	3 5/8						15.00	180,000
240,000	20.00	2 5/8	3 1/8	3 5/8	3 5/8	4 1/8						20.00	240,000
300,000	25.00	3 1/8	3 5/8	3 5/8	4 1/8	4 1/8						25.00	300,000
360,000	30.00	3 1/8	3 5/8	4 1/8	4 1/8	5 1/8						30.00	360,000
420,000	35.00	3 5/8	3 5/8	4 1/8	5 1/8	5 1/8	N/A	N/A	N/A	N/A	N/A	35.00	420,000
480,000	40.00	3 5/8	4 1/8	5 1/8	5 1/8	5 1/8						40.00	480,000
540,000	45.00	3 5/8	4 1/8	5 1/8	5 1/8	5 1/8						45.00	540,000
600,000	50.00	4 1/8	5 1/8	5 1/8	5 1/8	6 1/8						50.00	600,000

- Refer to DuPont Refrigerant Expert, version 2.0 for actual velocities and pressure drops.
- Equivalent length is actual length plus friction losses caused by fittings and accessories.
- Line sizes are expressed in outside diameter of type “L” copper tubing.
- Line sizes are calculated at rated full load system capacity.
- All selections are based on a maximum of 65° F return gas entering the compressor and a refrigerant condensing and liquid line temperature of 105° F.



Suva 134a Refrigerant Piping Guide



		Discharge Line Size Compressor to Condenser <small>1F° (2.2 psi) pressure drop maximum</small>					Liquid Condensate Line Condenser to Receiver <small>Condensate drain / vent</small>					Liquid Line Size Receiver to TXV <small>1F° (2.2 psi) pressure drop maximum</small>						
System Capacity BTU/Hr.	System Capacity Tons/Hr	Equivalent Line Lengths ... feet															System Capacity Tons/Hr	System Capacity BTU/Hr.
		25	50	75	100	150	25	50	75	100	150	25	50	75	100	150		
18,000	1.50	5/8	5/8	3/4	3/4	3/4	1/2	1/2	1/2	5/8	5/8	3/8	3/8	3/8	1/2	1/2	1.50	18,000
24,000	2.00	5/8	5/8	3/4	3/4	7/8	1/2	1/2	5/8	5/8	5/8	3/8	3/8	1/2	1/2	1/2	2.00	24,000
30,000	2.50	5/8	3/4	3/4	7/8	7/8	1/2	5/8	5/8	5/8	5/8	3/8	1/2	1/2	1/2	1/2	2.50	30,000
36,000	3.00	3/4	3/4	7/8	7/8	7/8	1/2	5/8	5/8	5/8	3/4	3/8	1/2	1/2	1/2	5/8	3.00	36,000
42,000	3.50	3/4	7/8	7/8	7/8	1 1/8	5/8	5/8	5/8	3/4	3/4	1/2	1/2	1/2	5/8	5/8	3.50	42,000
48,000	4.00	3/4	7/8	7/8	1 1/8	1 1/8	5/8	5/8	5/8	3/4	3/4	1/2	1/2	1/2	5/8	5/8	4.00	48,000
60,000	5.00	3/4	7/8	1 1/8	1 1/8	1 1/8	5/8	5/8	3/4	3/4	3/4	1/2	1/2	5/8	5/8	5/8	5.00	60,000
92,000	7.50	7/8	1 1/8	1 1/8	1 3/8	1 3/8	3/4	3/4	3/4	7/8	7/8	5/8	5/8	5/8	3/4	3/4	7.50	92,000
120,000	10.00	1 1/8	1 1/8	1 3/8	1 3/8	1 3/8	3/4	7/8	7/8	7/8	1 1/8	5/8	3/4	3/4	3/4	7/8	10.00	120,000
150,000	12.50	1 1/8	1 3/8	1 3/8	1 3/8	1 5/8	3/4	7/8	7/8	1 1/8	1 1/8	5/8	3/4	3/4	7/8	7/8	12.50	150,000
180,000	15.00	1 1/8	1 3/8	1 3/8	1 5/8	1 5/8	7/8	7/8	1 1/8	1 1/8	1 3/8	3/4	3/4	7/8	7/8	1 1/8	15.00	180,000
240,000	20.00	1 3/8	1 3/8	1 5/8	1 5/8	2 1/8	7/8	1 1/8	1 1/8	1 3/8	1 3/8	3/4	7/8	7/8	1 1/8	1 1/8	20.00	240,000
300,000	25.00	1 3/8	1 5/8	1 5/8	2 1/8	2 1/8	1 1/8	1 1/8	1 3/8	1 3/8	1 3/8	7/8	7/8	1 1/8	1 1/8	1 1/8	25.00	300,000
360,000	30.00	1 5/8	2 1/8	2 1/8	2 1/8	2 5/8	1 1/8	1 3/8	1 3/8	1 3/8	1 5/8	7/8	1 1/8	1 1/8	1 1/8	1 3/8	30.00	360,000
420,000	35.00	1 5/8	2 1/8	2 1/8	2 1/8	2 5/8	1 1/8	1 3/8	1 3/8	1 3/8	1 5/8	7/8	1 1/8	1 1/8	1 1/8	1 3/8	35.00	420,000
480,000	40.00	1 5/8	2 1/8	2 1/8	2 1/8	2 5/8	1 3/8	1 3/8	1 3/8	1 5/8	1 5/8	1 1/8	1 1/8	1 1/8	1 3/8	1 3/8	40.00	480,000
540,000	45.00	2 1/8	2 1/8	2 1/8	2 5/8	2 5/8	1 3/8	1 3/8	1 5/8	1 5/8	1 5/8	1 1/8	1 1/8	1 3/8	1 3/8	1 3/8	45.00	540,000
600,000	50.00	2 1/8	2 1/8	2 1/8	2 5/8	2 5/8	1 3/8	1 3/8	1 5/8	1 5/8	2 1/8	1 1/8	1 1/8	1 3/8	1 3/8	1 5/8	50.00	600,000

- Refer to DuPont Refrigerant Expert, version 2.0 for actual velocities and pressure drops.
- Equivalent length is actual length plus friction losses caused by fittings and accessories.
- Line sizes are expressed in outside diameter of type “L” copper tubing.
- Line sizes are calculated at rated full load system capacity.
- All selections are based on a maximum of 65° F return gas entering the compressor and a refrigerant condensing and liquid line temperature of 105° F.

SUVA 134a REFRIGERANT PRESSURE DROP IN LINES (65°F Evap Outlet)

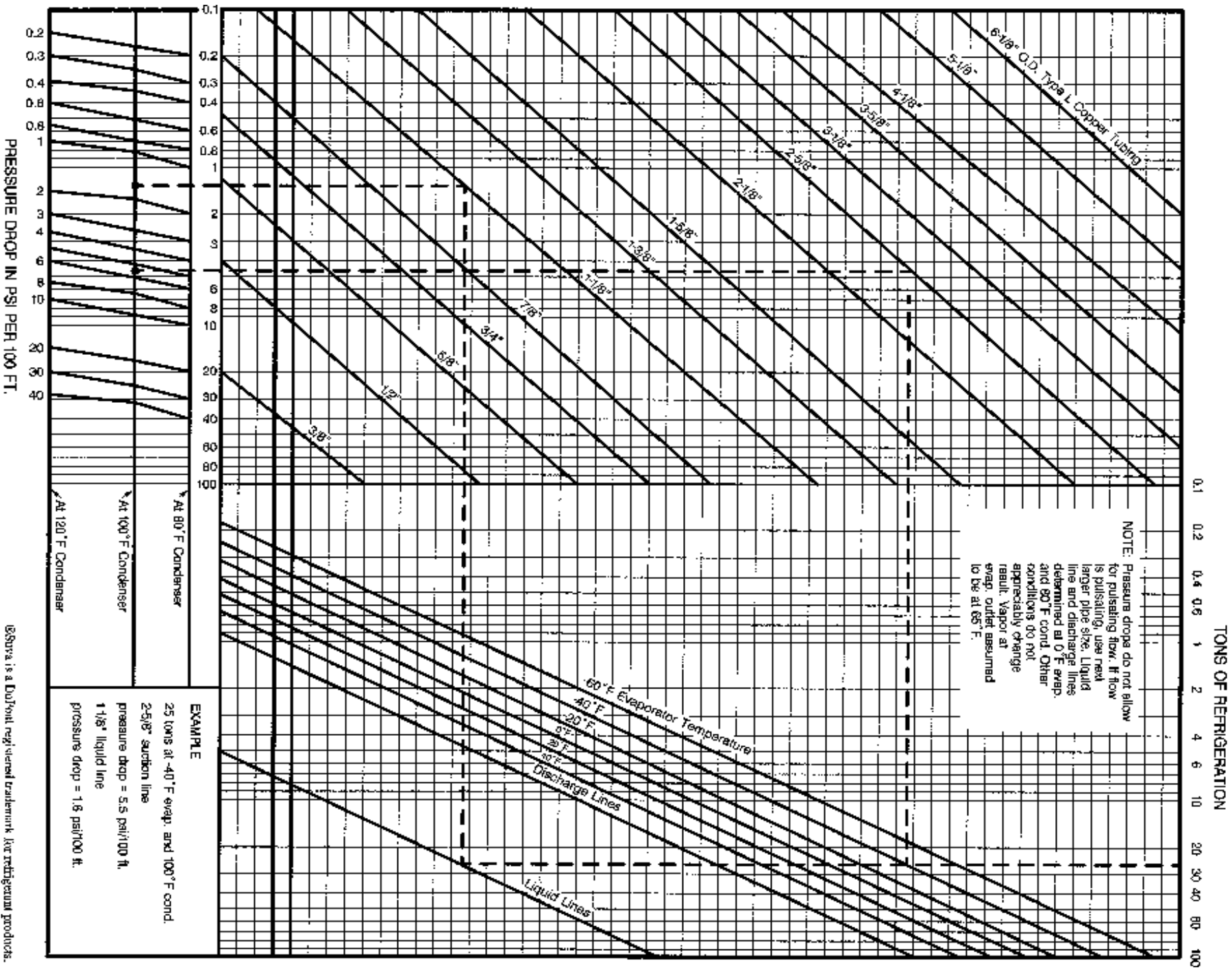

©Suva is a DuPont registered trademark for refrigerant products.

SUVA 134a REFRIGERANT VELOCITY IN LINES (65°F Evap. Outlet)

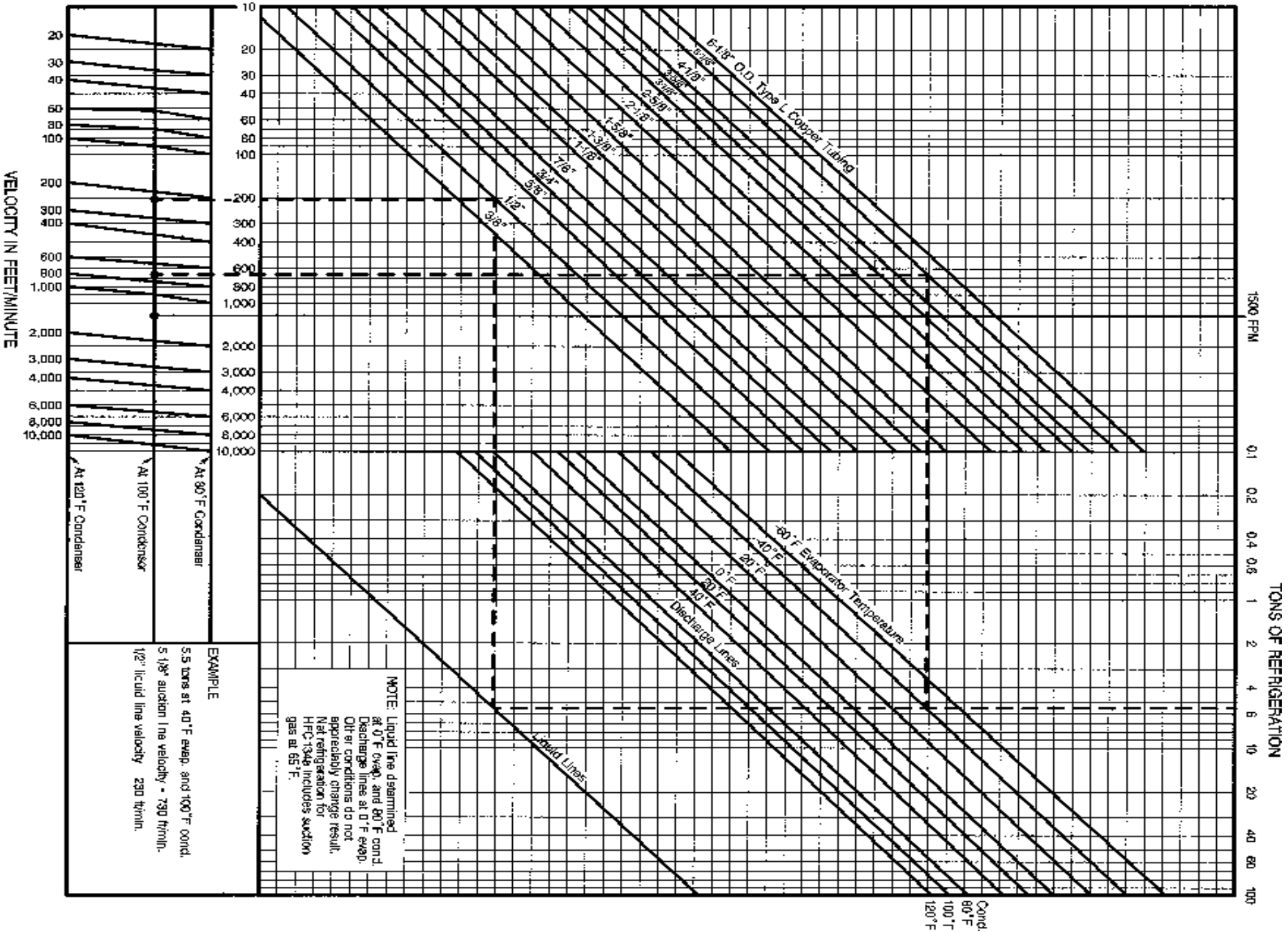



The miracles of science™

Suva[®]
refrigerants

Refrigerant

Suva 404A (R-404A)

Piping Guide

From 18,000 BTU through 600,000 BTU per hour at -50° F through +50° F saturated suction temperature. (1.5 ton through 50.0 tons)

" Quick Pick "



Suva 404A Refrigerant Piping Guide



Suction Line Size .. Evaporator to Compressor

		50° F through 30° F (104 through 70 psig)					29° F through 10° F (68 through 43 psig)					9° F through -10° F (42 through 24 psig)						
		Suggested Allowable Pressure Drop in psig = 2F°																
		3.4 lbs. (2F°)					2.6 lbs. (2F°)					1.9 lbs. (2F°)						
System Capacity BTU/Hr.	System Capacity Tons/Hr	Equivalent Suction Line Lengths ... feet															System Capacity Tons/Hr	System Capacity BTU/Hr.
		25	50	75	100	150	25	50	75	100	150	25	50	75	100	150		
18,000	1.50	5/8	5/8	3/4	3/4	3/4	5/8	3/4	3/4	7/8	7/8	3/4	7/8	7/8	1 1/8	1 1/8	1.50	18,000
24,000	2.00	5/8	3/4	7/8	7/8	7/8	3/4	3/4	7/8	7/8	1 1/8	3/4	7/8	1 1/8	1 1/8	1 1/8	2.00	24,000
30,000	2.50	3/4	3/4	7/8	7/8	1 1/8	3/4	7/8	7/8	1 1/8	1 1/8	7/8	1 1/8	1 1/8	1 1/8	1 1/8	2.50	30,000
36,000	3.00	3/4	7/8	7/8	7/8	1 1/8	7/8	7/8	1 1/8	1 1/8	1 1/8	7/8	1 1/8	1 1/8	1 1/8	1 3/8	3.00	36,000
42,000	3.50	3/4	7/8	7/8	1 1/8	1 1/8	7/8	1 1/8	1 1/8	1 1/8	1 3/8	1 1/8	1 1/8	1 1/8	1 3/8	1 3/8	3.50	42,000
48,000	4.00	3/4	7/8	1 1/8	1 1/8	1 1/8	7/8	1 1/8	1 1/8	1 1/8	1 3/8	1 1/8	1 1/8	1 3/8	1 3/8	1 3/8	4.00	48,000
60,000	5.00	7/8	7/8	1 1/8	1 1/8	1 3/8	1 1/8	1 1/8	1 1/8	1 3/8	1 3/8	1 1/8	1 3/8	1 3/8	1 3/8	1 5/8	5.00	60,000
92,000	7.50	1 1/8	1 1/8	1 3/8	1 3/8	1 3/8	1 1/8	1 3/8	1 3/8	1 3/8	1 5/8	1 3/8	1 3/8	1 5/8	1 5/8	2 1/8	7.50	92,000
120,000	10.00	1 1/8	1 3/8	1 3/8	1 3/8	1 5/8	1 3/8	1 3/8	1 5/8	1 5/8	2 1/8	1 3/8	1 5/8	1 5/8	2 1/8	2 1/8	10.00	120,000
150,000	12.50	1 1/8	1 3/8	1 3/8	1 5/8	1 5/8	1 3/8	1 5/8	1 5/8	2 1/8	2 1/8	1 5/8	2 1/8	2 1/8	2 1/8	2 1/8	12.50	150,000
180,000	15.00	1 3/8	1 3/8	1 5/8	1 5/8	2 1/8	1 3/8	1 5/8	2 1/8	2 1/8	2 1/8	1 5/8	2 1/8	2 1/8	2 1/8	2 5/8	15.00	180,000
240,000	20.00	1 3/8	1 5/8	2 1/8	2 1/8	2 1/8	1 5/8	2 1/8	2 1/8	2 1/8	2 1/8	2 1/8	2 1/8	2 1/8	2 5/8	2 5/8	20.00	240,000
300,000	25.00	1 5/8	2 1/8	2 1/8	2 1/8	2 1/8	1 5/8	2 1/8	2 1/8	2 5/8	2 5/8	2 1/8	2 5/8	2 5/8	2 5/8	3 1/8	25.00	300,000
360,000	30.00	1 5/8	2 1/8	2 1/8	2 1/8	2 5/8	2 1/8	2 1/8	2 5/8	2 5/8	2 5/8	2 1/8	2 5/8	2 5/8	2 5/8	3 1/8	30.00	360,000
420,000	35.00	2 1/8	2 1/8	2 1/8	2 5/8	2 5/8	2 1/8	2 5/8	2 5/8	2 5/8	2 5/8	2 1/8	2 5/8	2 5/8	3 1/8	3 1/8	35.00	420,000
480,000	40.00	2 1/8	2 1/8	2 1/8	2 5/8	2 5/8	2 1/8	2 5/8	2 5/8	2 5/8	3 1/8	2 5/8	2 5/8	3 1/8	3 1/8	3 5/8	40.00	480,000
540,000	45.00	2 1/8	2 1/8	2 5/8	2 5/8	2 5/8	2 1/8	2 5/8	2 5/8	3 1/8	3 1/8	2 5/8	3 1/8	3 1/8	3 1/8	3 5/8	45.00	540,000
600,000	50.00	2 1/8	2 1/8	2 5/8	2 5/8	3 1/8	2 1/8	2 5/8	2 5/8	3 1/8	3 1/8	2 5/8	3 1/8	3 1/8	3 5/8	3 5/8	50.00	600,000

- Refer to DuPont Refrigerant Expert, version 2.0 for actual velocities and pressure drops.
- Equivalent length is actual length plus friction losses caused by fittings and accessories.
- Line sizes are expressed in outside diameter of type “L” copper tubing.
- Line sizes are calculated at rated full load system capacity.
- All selections are based on a maximum of 65° F return gas entering the compressor and a refrigerant condensing and liquid line temperature of 105° F.



Suva 404A Refrigerant Piping Guide



Suction Line Size .. Evaporator to Compressor

		- 11° F through - 30° F (23 through 10 psig)					- 31° F through - 50° F (9 through 0 psig)						
		Suggested Allowable Pressure Drop in psig = 2F°											
		1.4 lbs. (2F°)					1.0 lbs. (2F°)						
System Capacity BTU/Hr.	System Capacity Tons/Hr	Equivalent Suction Lengths ... feet										System Capacity Tons/Hr	System Capacity BTU/Hr.
		25	50	75	100	150	25	50	75	100	150		
18,000	1.50	7/8	7/8	1 1/8	1 1/8	1 1/8	1 1/8	1 1/8	1 3/8	1 3/8	1 3/8	1.50	18,000
24,000	2.00	1 1/8	1 1/8	1 1/8	1 1/8	1 3/8	1 1/8	1 3/8	1 3/8	1 3/8	1 5/8	2.00	24,000
30,000	2.50	1 1/8	1 1/8	1 3/8	1 3/8	1 3/8	1 1/8	1 3/8	1 3/8	1 5/8	1 5/8	2.50	30,000
36,000	3.00	1 1/8	1 1/8	1 3/8	1 3/8	1 3/8	1 3/8	1 3/8	1 5/8	1 5/8	2 1/8	3.00	36,000
42,000	3.50	1 1/8	1 3/8	1 3/8	1 3/8	1 5/8	1 3/8	1 5/8	1 5/8	1 5/8	2 1/8	3.50	42,000
48,000	4.00	1 1/8	1 3/8	1 3/8	1 5/8	1 5/8	1 3/8	1 5/8	1 5/8	2 1/8	2 1/8	4.00	48,000
60,000	5.00	1 3/8	1 3/8	1 5/8	1 5/8	2 1/8	1 5/8	1 5/8	1 5/8	2 1/8	2 1/8	5.00	60,000
92,000	7.50	1 5/8	1 5/8	2 1/8	2 1/8	2 1/8	1 5/8	2 1/8	2 1/8	2 1/8	2 5/8	7.50	92,000
120,000	10.00	1 5/8	2 1/8	2 1/8	2 1/8	2 5/8	2 1/8	2 1/8	2 5/8	2 5/8	2 5/8	10.00	120,000
150,000	12.50	2 1/8	2 1/8	2 1/8	2 5/8	2 5/8	2 1/8	2 5/8	2 5/8	2 5/8	3 1/8	12.50	150,000
180,000	15.00	2 1/8	2 1/8	2 5/8	2 5/8	2 5/8	2 1/8	2 5/8	2 5/8	3 1/8	3 1/8	15.00	180,000
240,000	20.00	2 1/8	2 5/8	2 5/8	2 5/8	3 1/8	2 5/8	3 1/8	3 1/8	3 1/8	3 5/8	20.00	240,000
300,000	25.00	2 5/8	2 5/8	3 1/8	3 1/8	3 1/8	2 5/8	3 1/8	3 1/8	3 5/8	3 5/8	25.00	300,000
360,000	30.00	2 5/8	2 5/8	3 1/8	3 1/8	3 5/8	3 1/8	3 1/8	3 5/8	3 5/8	4 1/8	30.00	360,000
420,000	35.00	2 5/8	3 1/8	3 1/8	3 5/8	3 5/8	3 1/8	3 5/8	3 5/8	4 1/8	4 1/8	35.00	420,000
480,000	40.00	2 5/8	3 1/8	3 5/8	3 5/8	3 5/8	3 1/8	3 5/8	4 1/8	4 1/8	5 1/8	40.00	480,000
540,000	45.00	3 1/8	3 1/8	3 5/8	3 5/8	4 1/8	3 5/8	3 5/8	4 1/8	4 1/8	5 1/8	45.00	540,000
600,000	50.00	3 1/8	3 5/8	3 5/8	4 1/8	4 1/8	3 5/8	4 1/8	4 1/8	5 1/8	5 1/8	50.00	600,000

- Refer to DuPont Refrigerant Expert, version 2.0 for actual velocities and pressure drops.
- Equivalent length is actual length plus friction losses caused by fittings and accessories.
- Line sizes are expressed in outside diameter of type “L” copper tubing.
- Line sizes are calculated at rated full load system capacity.
- All selections are based on a maximum of 65° F return gas entering the compressor and a refrigerant condensing and liquid line temperature of 105° F.



Suva 404A Refrigerant Piping Guide



		Discharge Line Size Compressor to Condenser <small>1F° (3 psi) pressure drop maximum</small>					Liquid Condensate Line Condenser to Receiver <small>Condensate drain / vent</small>					Liquid Line Size Receiver to TXV <small>1F° (3 psi) pressure drop maximum</small>						
System Capacity BTU/Hr.	System Capacity Tons/Hr	Equivalent Line Lengths ... feet															System Capacity Tons/Hr	System Capacity BTU/Hr.
		25	50	75	100	150	25	50	75	100	150	25	50	75	100	150		
18,000	1.50	1/2	5/8	5/8	5/8	5/8	1/2	1/2	1/2	1/2	5/8	3/8	3/8	3/8	3/8	1/2	1.50	18,000
24,000	2.00	5/8	5/8	5/8	3/4	3/4	1/2	1/2	5/8	5/8	5/8	3/8	3/8	1/2	1/2	1/2	2.00	24,000
30,000	2.50	5/8	5/8	3/4	3/4	3/4	1/2	5/8	5/8	5/8	5/8	3/8	1/2	1/2	1/2	1/2	2.50	30,000
36,000	3.00	5/8	3/4	3/4	3/4	7/8	5/8	5/8	5/8	5/8	3/4	1/2	1/2	1/2	1/2	5/8	3.00	36,000
42,000	3.50	5/8	3/4	3/4	7/8	7/8	5/8	5/8	5/8	5/8	3/4	1/2	1/2	1/2	1/2	5/8	3.50	42,000
48,000	4.00	3/4	3/4	7/8	7/8	1 1/8	5/8	5/8	5/8	3/4	3/4	1/2	1/2	1/2	5/8	5/8	4.00	48,000
60,000	5.00	3/4	7/8	7/8	1 1/8	1 1/8	5/8	5/8	3/4	3/4	3/4	1/2	1/2	5/8	5/8	5/8	5.00	60,000
92,000	7.50	7/8	1 1/8	1 1/8	1 1/8	1 1/8	5/8	3/4	3/4	7/8	7/8	1/2	5/8	5/8	3/4	3/4	7.50	92,000
120,000	10.00	7/8	1 1/8	1 1/8	1 3/8	1 3/8	3/4	7/8	7/8	7/8	1 1/8	5/8	3/4	3/4	3/4	7/8	10.00	120,000
150,000	12.50	1 1/8	1 1/8	1 3/8	1 3/8	1 5/8	3/4	7/8	7/8	1 1/8	1 1/8	5/8	3/4	3/4	7/8	7/8	12.50	150,000
180,000	15.00	1 1/8	1 3/8	1 3/8	1 3/8	1 5/8	7/8	7/8	1 1/8	1 1/8	1 3/8	3/4	3/4	7/8	7/8	1 1/8	15.00	180,000
240,000	20.00	1 1/8	1 3/8	1 3/8	1 5/8	1 5/8	7/8	1 1/8	1 1/8	1 3/8	1 3/8	3/4	7/8	7/8	1 1/8	1 1/8	20.00	240,000
300,000	25.00	1 3/8	1 3/8	1 5/8	1 5/8	2 1/8	1 1/8	1 1/8	1 3/8	1 3/8	1 3/8	7/8	7/8	1 1/8	1 1/8	1 1/8	25.00	300,000
360,000	30.00	1 3/8	1 5/8	1 5/8	2 1/8	2 1/8	1 1/8	1 3/8	1 3/8	1 3/8	1 5/8	7/8	1 1/8	1 1/8	1 1/8	1 3/8	30.00	360,000
420,000	35.00	1 5/8	1 5/8	2 1/8	2 1/8	2 1/8	1 1/8	1 3/8	1 3/8	1 3/8	1 5/8	7/8	1 1/8	1 1/8	1 1/8	1 3/8	35.00	420,000
480,000	40.00	1 5/8	2 1/8	2 1/8	2 1/8	2 1/8	1 3/8	1 3/8	1 3/8	1 5/8	1 5/8	1 1/8	1 1/8	1 1/8	1 3/8	1 3/8	40.00	480,000
540,000	45.00	1 5/8	2 1/8	2 1/8	2 1/8	2 1/8	1 3/8	1 3/8	1 5/8	1 5/8	1 5/8	1 1/8	1 1/8	1 3/8	1 3/8	1 3/8	45.00	540,000
600,000	50.00	1 5/8	2 1/8	2 1/8	2 1/8	2 5/8	1 3/8	1 3/8	1 5/8	1 5/8	1 5/8	1 1/8	1 1/8	1 3/8	1 3/8	1 3/8	50.00	600,000

- Refer to DuPont Refrigerant Expert, version 2.0 for actual velocities and pressure drops.
- Equivalent length is actual length plus friction losses caused by fittings and accessories.
- Line sizes are expressed in outside diameter of type “L” copper tubing.
- Line sizes are calculated at rated full load system capacity.
- All selections are based on a maximum of 65° F return gas entering the compressor and a refrigerant condensing and liquid line temperature of 105° F.

SUVA 404A REFRIGERANT PRESSURE DROP IN LINES (65°F Evap. Outlet)

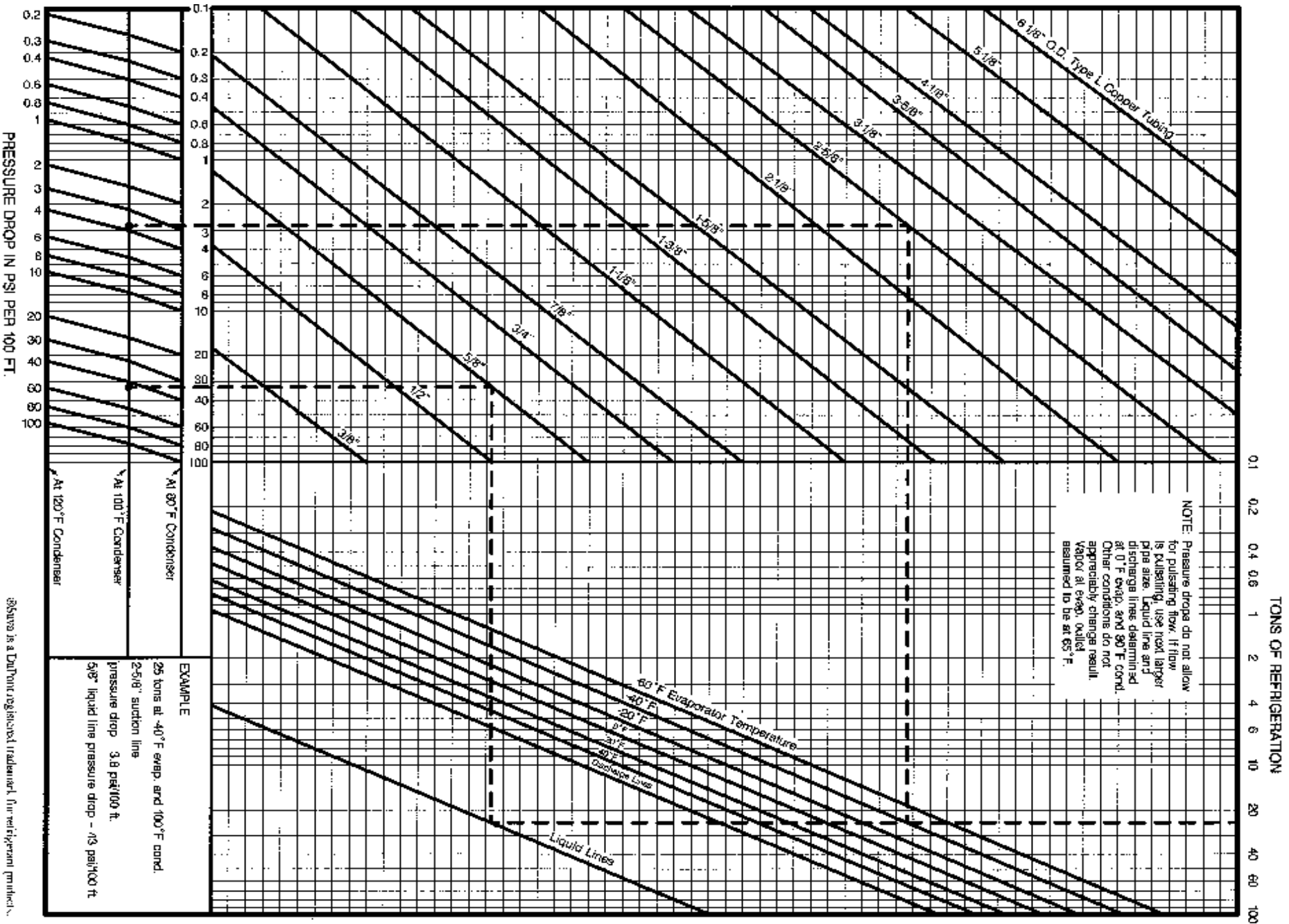

PRESSURE DROP IN PSI PER 100 FT.

SUVA is a DuPont registered trademark for refrigerant products.

SUVA 404A REFRIGERANT VELOCITY IN LINES (65°F Evap. Outlet)

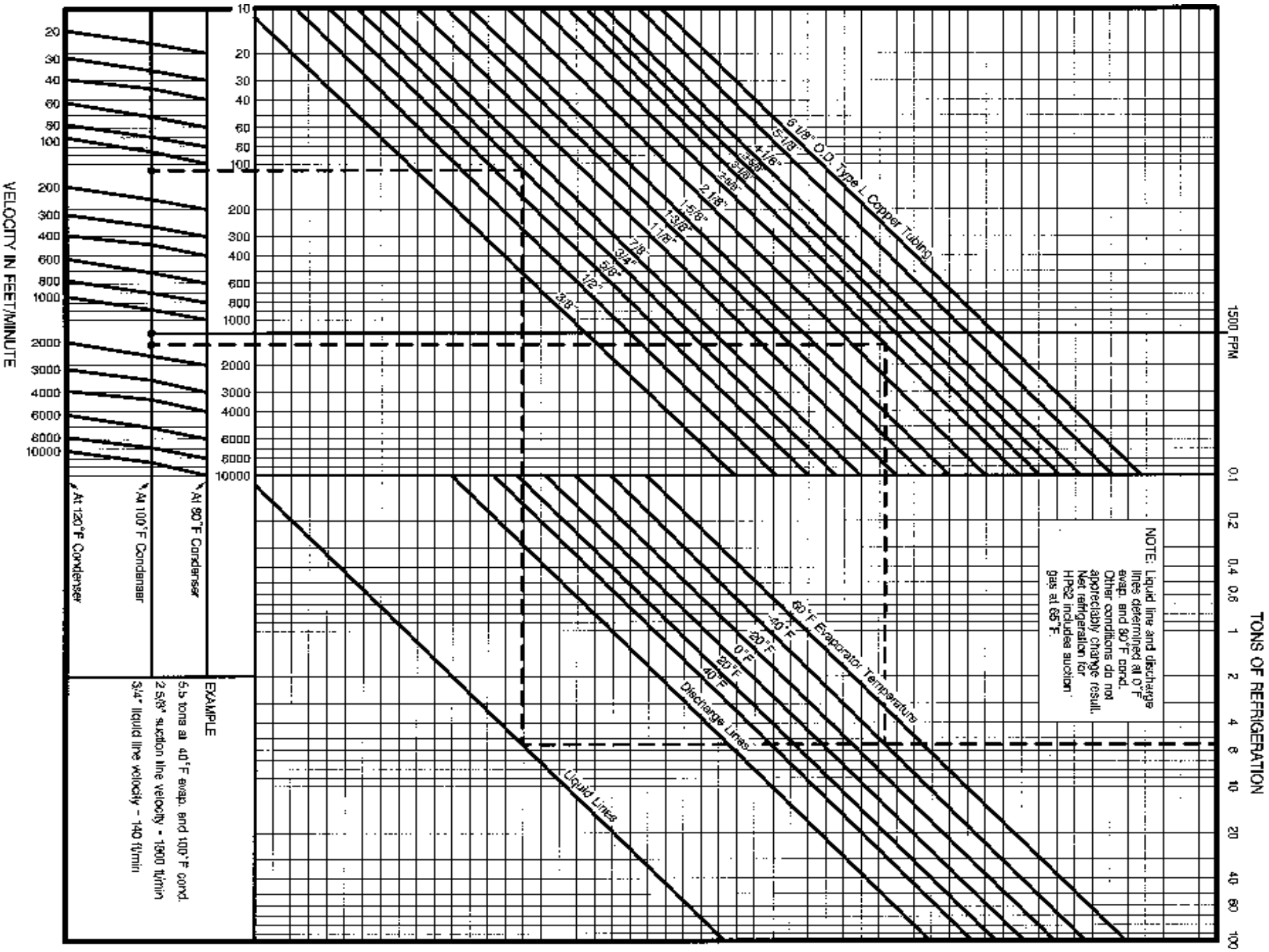



The miracles of science™

Suva[®]
refrigerants

Refrigerant

Suva 407C (R-407C)

Piping Guide

From 18,000 BTU through 600,000 BTU per hour at -30° F through +50° F saturated suction temperature. (1.5 ton through 50.0 tons)

" Quick Pick "



Suva 407C Refrigerant Piping Guide



Suction Line Size .. Evaporator to Compressor

		50° F through 30° F (77 through 48 psig)					29° F through 10° F (47 through 27 psig)					9° F through -10° F (26 through 12 psig)						
		Suggested Allowable Pressure Drop in psig = 2F°																
		2.5 lbs. (2F°)					1.8 lbs. (2F°)					1.3 lbs. (2F°)						
System Capacity BTU/Hr.	System Capacity Tons/Hr	Equivalent Suction Line Lengths ... feet															System Capacity Tons/Hr	System Capacity BTU/Hr.
		25	50	75	100	150	25	50	75	100	150	25	50	75	100	150		
18,000	1.50	5/8	3/4	3/4	3/4	7/8	3/4	3/4	7/8	7/8	1 1/8	3/4	7/8	1 1/8	1 1/8	1 1/8	1.50	18,000
24,000	2.00	3/4	3/4	7/8	7/8	7/8	3/4	7/8	7/8	1 1/8	1 1/8	7/8	1 1/8	1 1/8	1 1/8	1 3/8	2.00	24,000
30,000	2.50	3/4	7/8	7/8	7/8	1 1/8	7/8	7/8	7/8	1 1/8	1 1/8	1 1/8	1 1/8	1 1/8	1 3/8	1 3/8	2.50	30,000
36,000	3.00	3/4	7/8	7/8	1 1/8	1 1/8	7/8	1 1/8	1 1/8	1 1/8	1 3/8	1 1/8	1 1/8	1 3/8	1 3/8	1 3/8	3.00	36,000
42,000	3.50	3/4	7/8	1 1/8	1 1/8	1 1/8	7/8	1 1/8	1 1/8	1 1/8	1 3/8	1 1/8	1 3/8	1 3/8	1 3/8	1 5/8	3.50	42,000
48,000	4.00	7/8	1 1/8	1 1/8	1 1/8	1 1/8	1 1/8	1 1/8	1 1/8	1 3/8	1 3/8	1 1/8	1 3/8	1 3/8	1 5/8	4.00	48,000	
60,000	5.00	7/8	1 1/8	1 1/8	1 1/8	1 3/8	1 1/8	1 1/8	1 3/8	1 3/8	1 5/8	1 3/8	1 3/8	1 3/8	1 5/8	1 5/8	5.00	60,000
92,000	7.50	1 1/8	1 1/8	1 3/8	1 3/8	1 3/8	1 3/8	1 3/8	1 5/8	1 5/8	1 5/8	1 3/8	1 5/8	1 5/8	2 1/8	2 1/8	7.50	92,000
120,000	10.00	1 1/8	1 3/8	1 3/8	1 5/8	1 5/8	1 3/8	1 5/8	1 5/8	2 1/8	2 1/8	1 5/8	2 1/8	2 1/8	2 1/8	2 1/8	10.00	120,000
150,000	12.50	1 3/8	1 3/8	1 5/8	1 5/8	2 1/8	1 3/8	1 5/8	2 1/8	2 1/8	2 1/8	1 5/8	2 1/8	2 1/8	2 1/8	2 5/8	12.50	150,000
180,000	15.00	1 3/8	1 5/8	1 5/8	2 1/8	2 1/8	1 5/8	2 1/8	2 1/8	2 1/8	2 1/8	2 1/8	2 1/8	2 1/8	2 5/8	2 5/8	15.00	180,000
240,000	20.00	1 5/8	1 5/8	2 1/8	2 1/8	2 1/8	1 5/8	2 1/8	2 1/8	2 1/8	2 5/8	2 1/8	2 5/8	2 5/8	2 5/8	3 1/8	20.00	240,000
300,000	25.00	1 5/8	2 1/8	2 1/8	2 1/8	2 5/8	2 1/8	2 1/8	2 5/8	2 5/8	2 5/8	2 1/8	2 5/8	2 5/8	3 1/8	3 1/8	25.00	300,000
360,000	30.00	1 5/8	2 1/8	2 1/8	2 1/8	2 5/8	2 1/8	2 5/8	2 5/8	2 5/8	3 1/8	2 5/8	2 5/8	3 1/8	3 5/8	3.00	360,000	
420,000	35.00	2 1/8	2 1/8	2 1/8	2 5/8	2 5/8	2 1/8	2 5/8	2 5/8	2 5/8	3 1/8	2 5/8	3 1/8	3 1/8	3 5/8	35.00	420,000	
480,000	40.00	2 1/8	2 1/8	2 5/8	2 5/8	3 1/8	2 1/8	2 5/8	2 5/8	3 1/8	3 1/8	2 5/8	3 1/8	3 1/8	3 5/8	40.00	480,000	
540,000	45.00	2 1/8	2 5/8	2 5/8	2 5/8	3 1/8	2 5/8	2 5/8	3 1/8	3 1/8	3 5/8	2 5/8	3 1/8	3 1/8	3 5/8	45.00	540,000	
600,000	50.00	2 1/8	2 5/8	2 5/8	2 5/8	3 1/8	2 5/8	2 5/8	3 1/8	3 1/8	3 5/8	3 1/8	3 1/8	3 5/8	4 1/8	50.00	600,000	

- Refer to DuPont Refrigerant Expert, version 2.0 for actual velocities and pressure drops.
- Equivalent length is actual length plus friction losses caused by fittings and accessories.
- Line sizes are expressed in outside diameter of type “L” copper tubing.
- Line sizes are calculated at rated full load system capacity.
- All selections are based on a maximum of 65° F return gas entering the compressor and a refrigerant condensing and liquid line temperature of 105° F.



Suva 407C Refrigerant Piping Guide



Suction Line Size .. Evaporator to Compressor

		- 11° F through - 30° F (11 through 1 psig)					- 31° F through - 50° (1 psig through 11" Hg)						
		Suggested Allowable Pressure Drop in psig = 2F°											
		0.9 lbs. (2F°)					0.6 lbs. (2F°)						
System Capacity BTU/Hr.	System Capacity Tons/Hr	Equivalent Suction Lengths ... feet										System Capacity Tons/Hr	System Capacity BTU/Hr.
		25	50	75	100	150	25	50	75	100	150		
18,000	1.50	7/8	1 1/8	1 1/8	1 1/8	1 3/8						1.50	18,000
24,000	2.00	1 1/8	1 1/8	1 3/8	1 3/8	1 3/8						2.00	24,000
30,000	2.50	1 1/8	1 3/8	1 3/8	1 3/8	1 5/8	N/A	N/A	N/A	N/A	N/A	2.50	30,000
36,000	3.00	1 1/8	1 3/8	1 3/8	1 5/8	1 5/8						3.00	36,000
42,000	3.50	1 3/8	1 3/8	1 5/8	1 5/8	1 5/8						3.50	42,000
48,000	4.00	1 3/8	1 3/8	1 5/8	1 5/8	2 1/8						4.00	48,000
60,000	5.00	1 3/8	1 5/8	1 5/8	2 1/8	2 1/8						5.00	60,000
92,000	7.50	1 5/8	2 1/8	2 1/8	2 1/8	2 5/8						7.50	92,000
120,000	10.00	2 1/8	2 1/8	2 1/8	2 5/8	2 5/8	N/A	N/A	N/A	N/A	N/A	10.00	120,000
150,000	12.50	2 1/8	2 1/8	2 5/8	2 5/8	2 5/8						12.50	150,000
180,000	15.00	2 1/8	2 5/8	2 5/8	2 5/8	3 1/8						15.00	180,000
240,000	20.00	2 5/8	2 5/8	3 1/8	3 1/8	3 1/8						20.00	240,000
300,000	25.00	2 5/8	3 1/8	3 1/8	3 1/8	3 5/8						25.00	300,000
360,000	30.00	2 5/8	3 1/8	3 5/8	3 5/8	3 5/8						30.00	360,000
420,000	35.00	3 1/8	3 1/8	3 5/8	3 5/8	4 1/8	N/A	N/A	N/A	N/A	N/A	35.00	420,000
480,000	40.00	3 1/8	3 5/8	3 5/8	4 1/8	4 1/8						40.00	480,000
540,000	45.00	3 1/8	3 5/8	3 5/8	4 1/8	5 1/8						45.00	540,000
600,000	50.00	3 1/8	3 5/8	4 1/8	4 1/8	5 1/8						50.00	600,000

- Refer to DuPont Refrigerant Expert, version 2.0 for actual velocities and pressure drops.
- Equivalent length is actual length plus friction losses caused by fittings and accessories.
- Line sizes are expressed in outside diameter of type “L” copper tubing.
- Line sizes are calculated at rated full load system capacity.
- All selections are based on a maximum of 65° F return gas entering the compressor and a refrigerant condensing and liquid line temperature of 105° F.



Suva 407C Refrigerant Piping Guide



		Discharge Line Size Compressor to Condenser <small>1F° (3.2 psi) pressure drop maximum</small>					Liquid Condensate Line Condenser to Receiver <small>Condensate drain / vent</small>					Liquid Line Size Receiver to TXV <small>1F° (3.4 psi) pressure drop maximum</small>						
System Capacity BTU/Hr.	System Capacity Tons/Hr	Equivalent Line Lengths ... feet															System Capacity Tons/Hr	System Capacity BTU/Hr.
		25	50	75	100	150	25	50	75	100	150	25	50	75	100	150		
18,000	1.50	1/2	1/2	5/8	5/8	5/8	1/2	1/2	3/4	1/2	1/2	3/8	3/8	3/8	3/8	3/8	1.50	18,000
24,000	2.00	1/2	5/8	5/8	5/8	3/4	1/2	1/2	3/4	1/2	5/8	3/8	3/8	3/8	3/8	1/2	2.00	24,000
30,000	2.50	5/8	5/8	5/8	3/4	3/4	1/2	1/2	3/4	5/8	5/8	3/8	3/8	3/8	1/2	1/2	2.50	30,000
36,000	3.00	5/8	5/8	3/4	3/4	3/4	1/2	1/2	5/8	5/8	5/8	3/8	3/8	1/2	1/2	1/2	3.00	36,000
42,000	3.50	5/8	3/4	3/4	3/4	7/8	1/2	5/8	5/8	5/8	5/8	3/8	1/2	1/2	1/2	1/2	3.50	42,000
48,000	4.00	5/8	3/4	3/4	7/8	7/8	1/2	5/8	5/8	5/8	3/4	3/8	1/2	1/2	1/2	5/8	4.00	48,000
60,000	5.00	3/4	3/4	7/8	7/8	1 1/8	5/8	5/8	5/8	3/4	3/4	1/2	1/2	1/2	5/8	5/8	5.00	60,000
92,000	7.50	3/4	7/8	1 1/8	1 1/8	1 1/8	5/8	3/4	3/4	3/4	7/8	1/2	5/8	5/8	5/8	3/4	7.50	92,000
120,000	10.00	7/8	1 1/8	1 1/8	1 1/8	1 3/8	5/8	3/4	3/4	7/8	7/8	1/2	5/8	5/8	3/4	3/4	10.00	120,000
150,000	12.50	1 1/8	1 1/8	1 1/8	1 3/8	1 3/8	3/4	3/4	7/8	7/8	7/8	5/8	5/8	3/4	3/4	3/4	12.50	150,000
180,000	15.00	1 1/8	1 1/8	1 3/8	1 3/8	1 3/8	3/4	7/8	7/8	7/8	1 1/8	5/8	3/4	3/4	3/4	7/8	15.00	180,000
240,000	20.00	1 1/8	1 3/8	1 3/8	1 3/8	1 5/8	7/8	7/8	1 1/8	1 1/8	1 3/8	3/4	3/4	7/8	7/8	1 1/8	20.00	240,000
300,000	25.00	1 3/8	1 3/8	1 5/8	1 5/8	1 5/8	7/8	1 1/8	1 1/8	1 3/8	1 3/8	3/4	7/8	7/8	1 1/8	1 1/8	25.00	300,000
360,000	30.00	1 3/8	1 5/8	1 5/8	1 5/8	2 1/8	7/8	1 1/8	1 3/8	1 3/8	1 3/8	3/4	7/8	1 1/8	1 1/8	1 1/8	30.00	360,000
420,000	35.00	1 3/8	1 5/8	1 5/8	2 1/8	2 1/8	1 1/8	1 1/8	1 3/8	1 3/8	1 3/8	7/8	7/8	1 1/8	1 1/8	1 1/8	35.00	420,000
480,000	40.00	1 3/8	1 5/8	2 1/8	2 1/8	2 1/8	1 1/8	1 3/8	1 3/8	1 3/8	1 5/8	7/8	1 1/8	1 1/8	1 1/8	1 3/8	40.00	480,000
540,000	45.00	1 5/8	1 5/8	2 1/8	2 1/8	2 1/8	1 1/8	1 3/8	1 3/8	1 3/8	1 5/8	7/8	1 1/8	1 1/8	1 1/8	1 3/8	45.00	540,000
600,000	50.00	1 5/8	2 1/8	2 1/8	2 1/8	2 1/8	1 1/8	1 3/8	1 3/8	1 5/8	1 5/8	7/8	1 1/8	1 1/8	1 3/8	1 3/8	50.00	600,000

- Refer to DuPont Refrigerant Expert, version 2.0 for actual velocities and pressure drops.
- Equivalent length is actual length plus friction losses caused by fittings and accessories.
- Line sizes are expressed in outside diameter of type “L” copper tubing.
- Line sizes are calculated at rated full load system capacity.
- All selections are based on a maximum of 65° F return gas entering the compressor and a refrigerant condensing and liquid line temperature of 105° F.

SUVA 407C REFRIGERANT PRESSURE DROP IN LINES (65°F Evap Outlet)

TONS OF REFRIGERATION

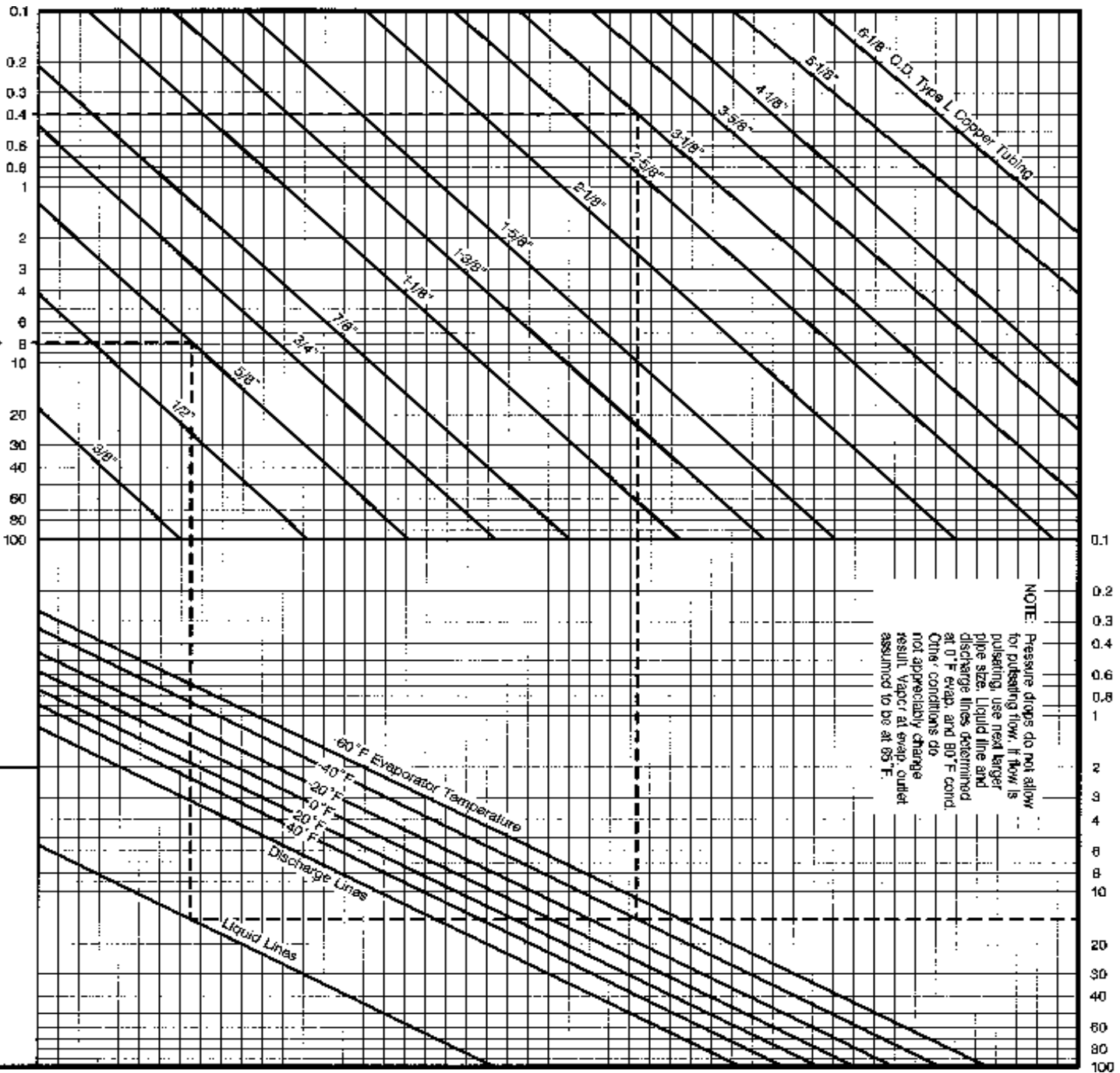

NOTE: Pressure drops do not allow for pulsating flow. If flow is pulsating, use next larger pipe size. Liquid line and discharge lines determined at 0°F evap. and 80°F cond. Other conditions do not appreciably change result. Vapor at evap. outlet assumed to be at 65°F.

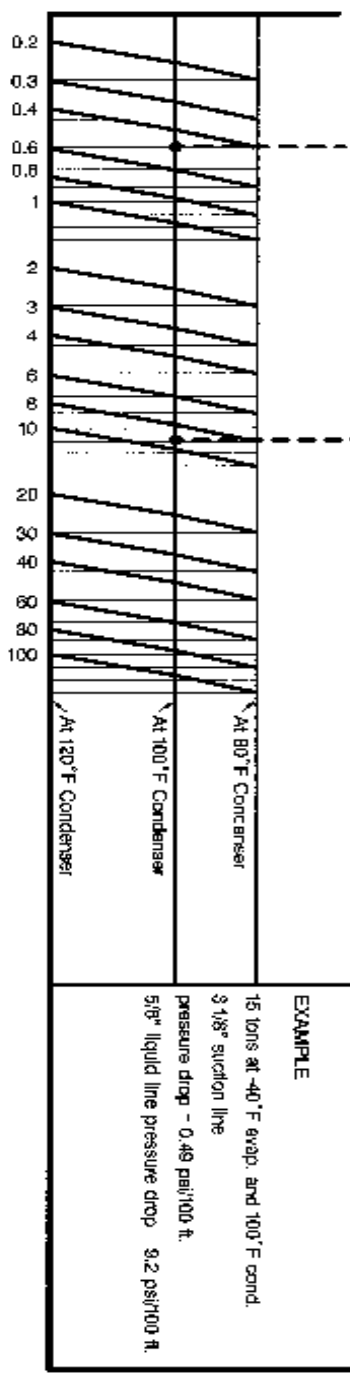

PRESSURE DROP IN PSI PER 100 FT.

SUVA is a DuPont registered trademark for refrigerant products.

SUVA 407C REFRIGERANT VELOCITY IN LINES (65°F Evap. Outlet)

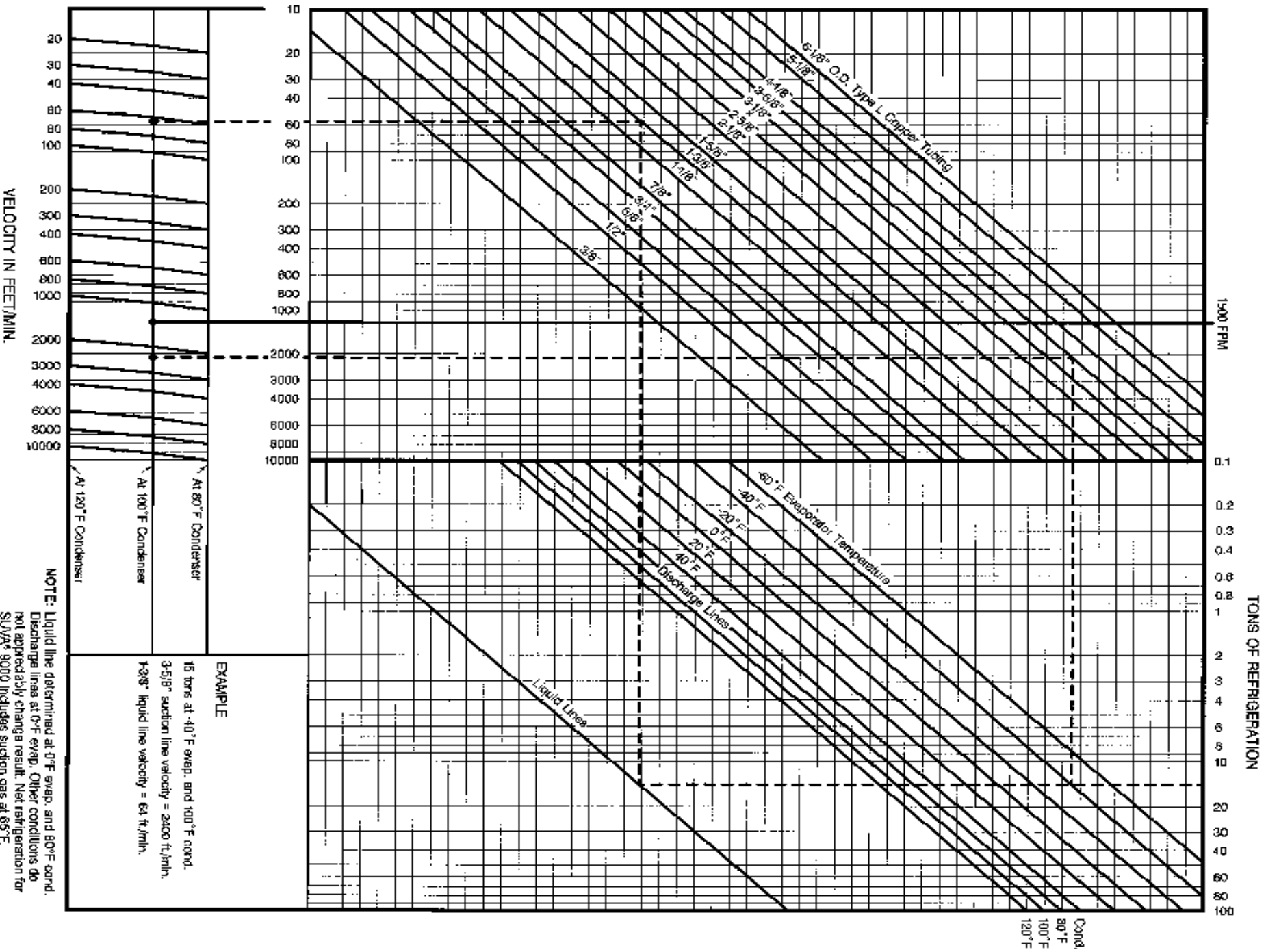



The miracles of science™

Suva[®]
refrigerants

Refrigerant

Suva 410A (R-410A)

Piping Guide

From 18,000 BTU through 600,000 BTU per hour at -50° F through + 50° F saturated suction temperature. (1.5 ton through 50.0 tons)

" Quick Pick "



Suva 410A Refrigerant Piping Guide



Suction Line Size .. Evaporator to Compressor

		50° F through 30° F (145 through 99 psig)					29° F through 10° F (97 through 64 psig)					9° F through -10° F (62 through 38 psig)						
		Suggested Allowable Pressure Drop in psig = 2F°																
		4.6 lbs. (2F°)					3.5 lbs. (2F°)					2.5 lbs. (2F°)						
System Capacity BTU/Hr.	System Capacity Tons/Hr	Equivalent Suction Line Lengths ... feet															System Capacity Tons/Hr	System Capacity BTU/Hr.
		25	50	75	100	150	25	50	75	100	150	25	50	75	100	150		
18,000	1.50	1/2	5/8	5/8	5/8	3/4	5/8	5/8	3/4	3/4	3/4	5/8	3/4	3/4	7/8	7/8	1.50	18,000
24,000	2.00	1/2	5/8	3/4	3/4	3/4	5/8	3/4	3/4	7/8	7/8	3/4	7/8	7/8	1 1/8	1 1/8	2.00	24,000
30,000	2.50	5/8	3/4	3/4	3/4	7/8	3/4	3/4	7/8	7/8	1 1/8	3/4	7/8	1 1/8	1 1/8	1 1/8	2.50	30,000
36,000	3.00	5/8	3/4	3/4	7/8	7/8	3/4	7/8	7/8	1 1/8	1 1/8	7/8	1 1/8	1 1/8	1 1/8	1 1/8	3.00	36,000
42,000	3.50	3/4	3/4	7/8	7/8	1 1/8	7/8	7/8	1 1/8	1 1/8	1 1/8	7/8	1 1/8	1 1/8	1 1/8	1 3/8	3.50	42,000
48,000	4.00	3/4	7/8	7/8	7/8	1 1/8	7/8	7/8	1 1/8	1 1/8	1 1/8	7/8	1 1/8	1 1/8	1 3/8	1 3/8	4.00	48,000
60,000	5.00	7/8	7/8	1 1/8	1 1/8	1 1/8	7/8	1 1/8	1 1/8	1 1/8	1 3/8	1 1/8	1 1/8	1 3/8	1 3/8	1 3/8	5.00	60,000
92,000	7.50	7/8	1 1/8	1 1/8	1 1/8	1 3/8	1 1/8	1 1/8	1 3/8	1 3/8	1 3/8	1 1/8	1 3/8	1 3/8	1 5/8	1 5/8	7.50	92,000
120,000	10.00	1 1/8	1 1/8	1 3/8	1 3/8	1 3/8	1 1/8	1 3/8	1 3/8	1 3/8	1 5/8	1 3/8	1 5/8	1 5/8	1 5/8	2 1/8	10.00	120,000
150,000	12.50	1 1/8	1 3/8	1 3/8	1 3/8	1 5/8	1 3/8	1 3/8	1 5/8	1 5/8	1 5/8	1 3/8	1 5/8	1 5/8	2 1/8	2 1/8	12.50	150,000
180,000	15.00	1 1/8	1 3/8	1 3/8	1 5/8	1 5/8	1 3/8	1 3/8	1 5/8	1 5/8	2 1/8	1 5/8	1 5/8	2 1/8	2 1/8	2 1/8	15.00	180,000
240,000	20.00	1 3/8	1 3/8	1 5/8	1 5/8	2 1/8	1 3/8	1 5/8	2 1/8	2 1/8	2 1/8	1 5/8	2 1/8	2 1/8	2 1/8	2 5/8	20.00	240,000
300,000	25.00	1 3/8	1 5/8	1 5/8	2 1/8	2 1/8	1 5/8	2 1/8	2 1/8	2 1/8	2 1/8	2 1/8	2 1/8	2 1/8	2 5/8	2 5/8	25.00	300,000
360,000	30.00	1 3/8	1 5/8	2 1/8	2 1/8	2 1/8	1 5/8	2 1/8	2 1/8	2 1/8	2 5/8	2 1/8	2 1/8	2 5/8	2 5/8	2 5/8	30.00	360,000
420,000	35.00	1 5/8	2 1/8	2 1/8	2 1/8	2 1/8	2 1/8	2 1/8	2 1/8	2 5/8	2 5/8	2 1/8	2 5/8	2 5/8	2 5/8	3 1/8	35.00	420,000
480,000	40.00	1 5/8	2 1/8	2 1/8	2 1/8	2 5/8	2 1/8	2 1/8	2 5/8	2 5/8	2 5/8	2 1/8	2 5/8	2 5/8	3 1/8	3 1/8	40.00	480,000
540,000	45.00	1 5/8	2 1/8	2 1/8	2 1/8	2 5/8	2 1/8	2 1/8	2 5/8	2 5/8	2 5/8	2 1/8	2 5/8	2 5/8	3 1/8	3 1/8	45.00	540,000
600,000	50.00	2 1/8	2 1/8	2 1/8	2 5/8	2 5/8	2 1/8	2 5/8	2 5/8	2 5/8	3 1/8	2 5/8	2 5/8	3 1/8	3 1/8	3 5/8	50.00	600,000

- Refer to DuPont Refrigerant Expert, version 2.0 for actual velocities and pressure drops.
- Equivalent length is actual length plus friction losses caused by fittings and accessories.
- Line sizes are expressed in outside diameter of type “L” copper tubing.
- Line sizes are calculated at rated full load system capacity.
- All selections are based on a maximum of 65° F return gas entering the compressor and a refrigerant condensing and liquid line temperature of 105° F.



Suva 410A Refrigerant Piping Guide



Suction Line Size .. Evaporator to Compressor

		- 11° F through - 30° F (37 through 19 psig)					- 31° F through - 50° F (18 through 6 psig)						
		Suggested Allowable Pressure Drop in psig = 2F°											
		1.9 lbs. (2F°)					1.3 lbs. (2F°)						
System Capacity BTU/Hr.	System Capacity Tons/Hr	Equivalent Suction Lengths ... feet										System Capacity Tons/Hr	System Capacity BTU/Hr.
		25	50	75	100	150	25	50	75	100	150		
18,000	1.50	3/4	7/8	7/8	1 1/8	1 1/8	7/8	1 1/8	1 1/8	1 1/8	1 3/8	1.50	18,000
24,000	2.00	7/8	1 1/8	1 1/8	1 1/8	1 1/8	1 1/8	1 1/8	1 3/8	1 3/8	1 3/8	2.00	24,000
30,000	2.50	7/8	1 1/8	1 1/8	1 1/8	1 3/8	1 1/8	1 3/8	1 3/8	1 3/8	1 5/8	2.50	30,000
36,000	3.00	1 1/8	1 1/8	1 1/8	1 3/8	1 3/8	1 1/8	1 3/8	1 3/8	1 5/8	1 5/8	3.00	36,000
42,000	3.50	1 1/8	1 1/8	1 3/8	1 3/8	1 3/8	1 3/8	1 3/8	1 5/8	1 5/8	1 5/8	3.50	42,000
48,000	4.00	1 1/8	1 3/8	1 3/8	1 3/8	1 5/8	1 3/8	1 3/8	1 5/8	1 5/8	2 1/8	4.00	48,000
60,000	5.00	1 3/8	1 3/8	1 3/8	1 5/8	1 5/8	1 3/8	1 5/8	1 5/8	2 1/8	2 1/8	5.00	60,000
92,000	7.50	1 3/8	1 5/8	1 5/8	2 1/8	2 1/8	1 5/8	1 5/8	2 1/8	2 1/8	2 5/8	7.50	92,000
120,000	10.00	1 5/8	1 5/8	2 1/8	2 1/8	2 1/8	2 1/8	2 1/8	2 1/8	2 5/8	2 5/8	10.00	120,000
150,000	12.50	1 5/8	2 1/8	2 1/8	2 1/8	2 5/8	2 1/8	2 1/8	2 5/8	2 5/8	2 5/8	12.50	150,000
180,000	15.00	2 1/8	2 1/8	2 1/8	2 5/8	2 5/8	2 1/8	2 5/8	2 5/8	2 5/8	3 1/8	15.00	180,000
240,000	20.00	2 1/8	2 1/8	2 5/8	2 5/8	2 5/8	2 5/8	2 5/8	3 1/8	3 1/8	3 5/8	20.00	240,000
300,000	25.00	2 1/8	2 5/8	2 5/8	2 5/8	3 1/8	2 5/8	3 1/8	3 1/8	3 1/8	3 5/8	25.00	300,000
360,000	30.00	2 1/8	2 5/8	2 5/8	3 1/8	3 1/8	2 5/8	3 1/8	3 5/8	3 5/8	3 5/8	30.00	360,000
420,000	35.00	2 5/8	2 5/8	3 1/8	3 1/8	3 5/8	3 1/8	3 5/8	3 5/8	3 5/8	4 1/8	35.00	420,000
480,000	40.00	2 5/8	3 1/8	3 1/8	3 1/8	3 5/8	3 1/8	3 5/8	3 5/8	4 1/8	4 1/8	40.00	480,000
540,000	45.00	2 5/8	3 1/8	3 1/8	3 5/8	3 5/8	3 1/8	3 5/8	3 5/8	4 1/8	5 1/8	45.00	540,000
600,000	50.00	2 5/8	3 1/8	3 5/8	3 5/8	4 1/8	3 5/8	3 5/8	4 1/8	4 1/8	5 1/8	50.00	600,000

- Refer to DuPont Refrigerant Expert, version 2.0 for actual velocities and pressure drops.
- Equivalent length is actual length plus friction losses caused by fittings and accessories.
- Line sizes are expressed in outside diameter of type “L” copper tubing.
- Line sizes are calculated at rated full load system capacity.
- All selections are based on a maximum of 65° F return gas entering the compressor and a refrigerant condensing and liquid line temperature of 105° F.



Suva 410A Refrigerant Piping Guide



		Discharge Line Size Compressor to Condenser <small>1F° (5 psi) pressure drop maximum</small>					Liquid Condensate Line Condenser to Receiver <small>Condensate drain / vent</small>					Liquid Line Size Receiver to TXV <small>1F° (5 psi) pressure drop maximum</small>						
System Capacity BTU/Hr.	System Capacity Tons/Hr	Equivalent Line Lengths ... feet															System Capacity Tons/Hr	System Capacity BTU/Hr.
		25	50	75	100	150	25	50	75	100	150	25	50	75	100	150		
18,000	1.50	1/2	1/2	1/2	5/8	5/8	1/2	1/2	1/2	1/2	1/2	3/8	3/8	3/8	3/8	3/8	1.50	18,000
24,000	2.00	1/2	5/8	5/8	5/8	5/8	1/2	1/2	1/2	5/8	5/8	3/8	3/8	3/8	1/2	1/2	2.00	24,000
30,000	2.50	1/2	5/8	5/8	5/8	3/4	1/2	1/2	5/8	5/8	5/8	3/8	3/8	1/2	1/2	1/2	2.50	30,000
36,000	3.00	5/8	5/8	5/8	3/4	3/4	1/2	1/2	5/8	5/8	5/8	3/8	3/8	1/2	1/2	1/2	3.00	36,000
42,000	3.50	5/8	5/8	3/4	3/4	3/4	1/2	5/8	5/8	5/8	5/8	3/8	1/2	1/2	1/2	1/2	3.50	42,000
48,000	4.00	5/8	3/4	3/4	3/4	7/8	5/8	5/8	5/8	5/8	3/4	1/2	1/2	1/2	1/2	5/8	4.00	48,000
60,000	5.00	3/4	3/4	7/8	7/8	7/8	5/8	5/8	5/8	3/4	3/4	1/2	1/2	1/2	5/8	5/8	5.00	60,000
92,000	7.50	3/4	7/8	7/8	1 1/8	1 1/8	5/8	3/4	3/4	3/4	7/8	1/2	5/8	5/8	5/8	3/4	7.50	92,000
120,000	10.00	7/8	1 1/8	1 1/8	1 1/8	1 1/8	5/8	3/4	3/4	7/8	7/8	1/2	5/8	5/8	3/4	3/4	10.00	120,000
150,000	12.50	7/8	1 1/8	1 1/8	1 1/8	1 3/8	3/4	3/4	7/8	7/8	1 1/8	5/8	5/8	3/4	3/4	7/8	12.50	150,000
180,000	15.00	1 1/8	1 1/8	1 1/8	1 3/8	1 3/8	3/4	7/8	7/8	1 1/8	1 1/8	5/8	3/4	3/4	7/8	7/8	15.00	180,000
240,000	20.00	1 1/8	1 3/8	1 3/8	1 3/8	1 5/8	7/8	7/8	1 1/8	1 1/8	1 3/8	3/4	3/4	7/8	7/8	1 1/8	20.00	240,000
300,000	25.00	1 1/8	1 3/8	1 3/8	1 5/8	1 5/8	7/8	1 1/8	1 1/8	1 3/8	1 3/8	3/4	7/8	7/8	1 1/8	1 1/8	25.00	300,000
360,000	30.00	1 3/8	1 3/8	1 5/8	1 5/8	1 5/8	7/8	1 1/8	1 3/8	1 3/8	1 3/8	3/4	7/8	1 1/8	1 1/8	1 1/8	30.00	360,000
420,000	35.00	1 3/8	1 5/8	1 5/8	1 5/8	2 1/8	1 1/8	1 3/8	1 3/8	1 3/8	1 3/8	7/8	1 1/8	1 1/8	1 1/8	1 1/8	35.00	420,000
480,000	40.00	1 3/8	1 5/8	1 5/8	2 1/8	2 1/8	1 1/8	1 3/8	1 3/8	1 3/8	1 5/8	7/8	1 1/8	1 1/8	1 1/8	1 3/8	40.00	480,000
540,000	45.00	1 3/8	1 5/8	1 5/8	2 1/8	2 1/8	1 1/8	1 3/8	1 3/8	1 3/8	1 5/8	7/8	1 1/8	1 1/8	1 1/8	1 3/8	45.00	540,000
600,000	50.00	1 5/8	1 5/8	2 1/8	2 1/8	2 1/8	1 3/8	1 3/8	1 3/8	1 5/8	1 5/8	1 1/8	1 1/8	1 1/8	1 3/8	1 3/8	50.00	600,000

- Refer to DuPont Refrigerant Expert, version 2.0 for actual velocities and pressure drops.
- Equivalent length is actual length plus friction losses caused by fittings and accessories.
- Line sizes are expressed in outside diameter of type “L” copper tubing.
- Line sizes are calculated at rated full load system capacity.
- All selections are based on a maximum of 65° F return gas entering the compressor and a refrigerant condensing and liquid line temperature of 105° F.



The miracles of science™

Suva[®]
refrigerants

Refrigerant

Suva 507 (R-507)

Piping Guide

From 18,000 BTU through 600,000 BTU per hour at -50° F through + 50° F saturated suction temperature. (1.5 ton through 50.0 tons)

" Quick Pick "



Suva 507 Refrigerant Piping Guide



Suction Line Size .. Evaporator to Compressor

		50° F through 30° F (104 through 70 psig)					29° F through 10° F (68 through 43 psig)					9° F through -10° F (42 through 24 psig)						
		Suggested Allowable Pressure Drop in psig = 2F°																
		3.4 lbs. (2F°)					2.6 lbs. (2F°)					1.9 lbs. (2F°)						
System Capacity BTU/Hr.	System Capacity Tons/Hr	Equivalent Suction Line Lengths ... feet															System Capacity Tons/Hr	System Capacity BTU/Hr.
		25	50	75	100	150	25	50	75	100	150	25	50	75	100	150		
18,000	1.50	5/8	5/8	3/4	3/4	3/4	5/8	3/4	3/4	7/8	7/8	3/4	7/8	7/8	1 1/8	1 1/8	1.50	18,000
24,000	2.00	5/8	3/4	7/8	7/8	7/8	3/4	3/4	7/8	7/8	1 1/8	3/4	7/8	1 1/8	1 1/8	1 1/8	2.00	24,000
30,000	2.50	3/4	3/4	7/8	7/8	1 1/8	3/4	7/8	7/8	1 1/8	1 1/8	7/8	1 1/8	1 1/8	1 1/8	1 1/8	2.50	30,000
36,000	3.00	3/4	7/8	7/8	7/8	1 1/8	7/8	7/8	1 1/8	1 1/8	1 1/8	7/8	1 1/8	1 1/8	1 1/8	1 3/8	3.00	36,000
42,000	3.50	3/4	7/8	7/8	1 1/8	1 1/8	7/8	1 1/8	1 1/8	1 1/8	1 3/8	1 1/8	1 1/8	1 1/8	1 3/8	1 3/8	3.50	42,000
48,000	4.00	3/4	7/8	1 1/8	1 1/8	1 1/8	7/8	1 1/8	1 1/8	1 1/8	1 3/8	1 1/8	1 1/8	1 3/8	1 3/8	1 3/8	4.00	48,000
60,000	5.00	7/8	7/8	1 1/8	1 1/8	1 3/8	1 1/8	1 1/8	1 1/8	1 3/8	1 3/8	1 1/8	1 3/8	1 3/8	1 3/8	1 5/8	5.00	60,000
92,000	7.50	1 1/8	1 1/8	1 3/8	1 3/8	1 3/8	1 1/8	1 3/8	1 3/8	1 3/8	1 5/8	1 3/8	1 3/8	1 5/8	1 5/8	2 1/8	7.50	92,000
120,000	10.00	1 1/8	1 3/8	1 3/8	1 3/8	1 5/8	1 3/8	1 3/8	1 5/8	1 5/8	2 1/8	1 3/8	1 5/8	1 5/8	2 1/8	2 1/8	10.00	120,000
150,000	12.50	1 1/8	1 3/8	1 3/8	1 5/8	1 5/8	1 3/8	1 5/8	1 5/8	2 1/8	2 1/8	1 5/8	2 1/8	2 1/8	2 1/8	2 1/8	12.50	150,000
180,000	15.00	1 3/8	1 3/8	1 5/8	1 5/8	2 1/8	1 3/8	1 5/8	2 1/8	2 1/8	2 1/8	1 5/8	2 1/8	2 1/8	2 1/8	2 5/8	15.00	180,000
240,000	20.00	1 3/8	1 5/8	2 1/8	2 1/8	2 1/8	1 5/8	2 1/8	2 1/8	2 1/8	2 1/8	2 1/8	2 1/8	2 1/8	2 5/8	2 5/8	20.00	240,000
300,000	25.00	1 5/8	2 1/8	2 1/8	2 1/8	2 1/8	1 5/8	2 1/8	2 1/8	2 5/8	2 5/8	2 1/8	2 5/8	2 5/8	2 5/8	3 1/8	25.00	300,000
360,000	30.00	1 5/8	2 1/8	2 1/8	2 1/8	2 5/8	2 1/8	2 1/8	2 5/8	2 5/8	2 5/8	2 1/8	2 5/8	2 5/8	2 5/8	3 1/8	30.00	360,000
420,000	35.00	2 1/8	2 1/8	2 1/8	2 5/8	2 5/8	2 1/8	2 5/8	2 5/8	2 5/8	2 5/8	2 1/8	2 5/8	2 5/8	3 1/8	3 1/8	35.00	420,000
480,000	40.00	2 1/8	2 1/8	2 1/8	2 5/8	2 5/8	2 1/8	2 5/8	2 5/8	2 5/8	3 1/8	2 5/8	2 5/8	3 1/8	3 1/8	3 5/8	40.00	480,000
540,000	45.00	2 1/8	2 1/8	2 5/8	2 5/8	2 5/8	2 1/8	2 5/8	2 5/8	3 1/8	3 1/8	2 5/8	3 1/8	3 1/8	3 1/8	3 5/8	45.00	540,000
600,000	50.00	2 1/8	2 1/8	2 5/8	2 5/8	3 1/8	2 1/8	2 5/8	2 5/8	3 1/8	3 1/8	2 5/8	3 1/8	3 1/8	3 5/8	3 5/8	50.00	600,000

- Refer to DuPont Refrigerant Expert, version 2.0. Suva 404A (R-404A) for actual velocities and pressure drops.
- Equivalent length is actual length plus friction losses caused by fittings and accessories.
- Line sizes are expressed in outside diameter of type “L” copper tubing.
- Line sizes are calculated at rated full load system capacity.
- All selections are based on a maximum of 65° F return gas entering the compressor and a refrigerant condensing and liquid line temperature of 105° F.



Suva 507 Refrigerant Piping Guide



Suction Line Size .. Evaporator to Compressor

		- 11° F through - 30° F (23 through 10 psig)					- 31° F through - 50° F (9 through 0 psig)						
		Suggested Allowable Pressure Drop in psig = 2F°											
		1.4 lbs. (2F°)					1.0 lbs. (2F°)						
System Capacity BTU/Hr.	System Capacity Tons/Hr	Equivalent Suction Lengths ... feet										System Capacity Tons/Hr	System Capacity BTU/Hr.
		25	50	75	100	150	25	50	75	100	150		
18,000	1.50	7/8	7/8	1 1/8	1 1/8	1 1/8	1 1/8	1 1/8	1 3/8	1 3/8	1 3/8	1.50	18,000
24,000	2.00	1 1/8	1 1/8	1 1/8	1 1/8	1 3/8	1 1/8	1 3/8	1 3/8	1 3/8	1 5/8	2.00	24,000
30,000	2.50	1 1/8	1 1/8	1 3/8	1 3/8	1 3/8	1 1/8	1 3/8	1 3/8	1 5/8	1 5/8	2.50	30,000
36,000	3.00	1 1/8	1 1/8	1 3/8	1 3/8	1 3/8	1 3/8	1 3/8	1 5/8	1 5/8	2 1/8	3.00	36,000
42,000	3.50	1 1/8	1 3/8	1 3/8	1 3/8	1 5/8	1 3/8	1 5/8	1 5/8	1 5/8	2 1/8	3.50	42,000
48,000	4.00	1 1/8	1 3/8	1 3/8	1 5/8	1 5/8	1 3/8	1 5/8	1 5/8	2 1/8	2 1/8	4.00	48,000
60,000	5.00	1 3/8	1 3/8	1 5/8	1 5/8	2 1/8	1 5/8	1 5/8	1 5/8	2 1/8	2 1/8	5.00	60,000
92,000	7.50	1 5/8	1 5/8	2 1/8	2 1/8	2 1/8	1 5/8	2 1/8	2 1/8	2 1/8	2 5/8	7.50	92,000
120,000	10.00	1 5/8	2 1/8	2 1/8	2 1/8	2 5/8	2 1/8	2 1/8	2 5/8	2 5/8	2 5/8	10.00	120,000
150,000	12.50	2 1/8	2 1/8	2 1/8	2 5/8	2 5/8	2 1/8	2 5/8	2 5/8	2 5/8	3 1/8	12.50	150,000
180,000	15.00	2 1/8	2 1/8	2 5/8	2 5/8	2 5/8	2 1/8	2 5/8	2 5/8	3 1/8	3 1/8	15.00	180,000
240,000	20.00	2 1/8	2 5/8	2 5/8	2 5/8	3 1/8	2 5/8	3 1/8	3 1/8	3 1/8	3 5/8	20.00	240,000
300,000	25.00	2 5/8	2 5/8	3 1/8	3 1/8	3 1/8	2 5/8	3 1/8	3 1/8	3 5/8	3 5/8	25.00	300,000
360,000	30.00	2 5/8	2 5/8	3 1/8	3 1/8	3 5/8	3 1/8	3 1/8	3 5/8	3 5/8	4 1/8	30.00	360,000
420,000	35.00	2 5/8	3 1/8	3 1/8	3 5/8	3 5/8	3 1/8	3 5/8	3 5/8	4 1/8	4 1/8	35.00	420,000
480,000	40.00	2 5/8	3 1/8	3 5/8	3 5/8	3 5/8	3 1/8	3 5/8	4 1/8	4 1/8	5 1/8	40.00	480,000
540,000	45.00	3 1/8	3 1/8	3 5/8	3 5/8	4 1/8	3 5/8	3 5/8	4 1/8	4 1/8	5 1/8	45.00	540,000
600,000	50.00	3 1/8	3 5/8	3 5/8	4 1/8	4 1/8	3 5/8	4 1/8	4 1/8	5 1/8	5 1/8	50.00	600,000

- Refer to DuPont Refrigerant Expert, version 2.0. Suva 404A (R-404A) for actual velocities and pressure drops.
- Equivalent length is actual length plus friction losses caused by fittings and accessories.
- Line sizes are expressed in outside diameter of type “L” copper tubing.
- Line sizes are calculated at rated full load system capacity.
- All selections are based on a maximum of 65° F return gas entering the compressor and a refrigerant condensing and liquid line temperature of 105° F.



Suva 507 Refrigerant Piping Guide



		Discharge Line Size Compressor to Condenser <small>1F° (3 psi) pressure drop maximum</small>					Liquid Condensate Line Condenser to Receiver <small>Condensate drain / vent</small>					Liquid Line Size Receiver to TXV <small>1F° (3 psi) pressure drop maximum</small>						
System Capacity BTU/Hr.	System Capacity Tons/Hr	Equivalent Line Lengths ... feet															System Capacity Tons/Hr	System Capacity BTU/Hr.
		25	50	75	100	150	25	50	75	100	150	25	50	75	100	150		
18,000	1.50	1/2	5/8	5/8	5/8	5/8	1/2	1/2	1/2	1/2	5/8	3/8	3/8	3/8	3/8	1/2	1.50	18,000
24,000	2.00	5/8	5/8	5/8	3/4	3/4	1/2	1/2	5/8	5/8	5/8	3/8	3/8	1/2	1/2	1/2	2.00	24,000
30,000	2.50	5/8	5/8	3/4	3/4	3/4	1/2	5/8	5/8	5/8	5/8	3/8	1/2	1/2	1/2	1/2	2.50	30,000
36,000	3.00	5/8	3/4	3/4	3/4	7/8	5/8	5/8	5/8	5/8	3/4	1/2	1/2	1/2	1/2	5/8	3.00	36,000
42,000	3.50	5/8	3/4	3/4	7/8	7/8	5/8	5/8	5/8	5/8	3/4	1/2	1/2	1/2	1/2	5/8	3.50	42,000
48,000	4.00	3/4	3/4	7/8	7/8	1 1/8	5/8	5/8	5/8	3/4	3/4	1/2	1/2	1/2	5/8	5/8	4.00	48,000
60,000	5.00	3/4	7/8	7/8	1 1/8	1 1/8	5/8	5/8	3/4	3/4	3/4	1/2	1/2	5/8	5/8	5/8	5.00	60,000
92,000	7.50	7/8	1 1/8	1 1/8	1 1/8	1 1/8	5/8	3/4	3/4	7/8	7/8	1/2	5/8	5/8	3/4	3/4	7.50	92,000
120,000	10.00	7/8	1 1/8	1 1/8	1 3/8	1 3/8	3/4	7/8	7/8	7/8	1 1/8	5/8	3/4	3/4	3/4	7/8	10.00	120,000
150,000	12.50	1 1/8	1 1/8	1 3/8	1 3/8	1 5/8	3/4	7/8	7/8	1 1/8	1 1/8	5/8	3/4	3/4	7/8	7/8	12.50	150,000
180,000	15.00	1 1/8	1 3/8	1 3/8	1 3/8	1 5/8	7/8	7/8	1 1/8	1 1/8	1 3/8	3/4	3/4	7/8	7/8	1 1/8	15.00	180,000
240,000	20.00	1 1/8	1 3/8	1 3/8	1 5/8	1 5/8	7/8	1 1/8	1 1/8	1 3/8	1 3/8	3/4	7/8	7/8	1 1/8	1 1/8	20.00	240,000
300,000	25.00	1 3/8	1 3/8	1 5/8	1 5/8	2 1/8	1 1/8	1 1/8	1 3/8	1 3/8	1 3/8	7/8	7/8	1 1/8	1 1/8	1 1/8	25.00	300,000
360,000	30.00	1 3/8	1 5/8	1 5/8	2 1/8	2 1/8	1 1/8	1 3/8	1 3/8	1 3/8	1 5/8	7/8	1 1/8	1 1/8	1 1/8	1 3/8	30.00	360,000
420,000	35.00	1 5/8	1 5/8	2 1/8	2 1/8	2 1/8	1 1/8	1 3/8	1 3/8	1 3/8	1 5/8	7/8	1 1/8	1 1/8	1 1/8	1 3/8	35.00	420,000
480,000	40.00	1 5/8	2 1/8	2 1/8	2 1/8	2 1/8	1 3/8	1 3/8	1 3/8	1 5/8	1 5/8	1 1/8	1 1/8	1 1/8	1 3/8	1 3/8	40.00	480,000
540,000	45.00	1 5/8	2 1/8	2 1/8	2 1/8	2 1/8	1 3/8	1 3/8	1 5/8	1 5/8	1 5/8	1 1/8	1 1/8	1 3/8	1 3/8	1 3/8	45.00	540,000
600,000	50.00	1 5/8	2 1/8	2 1/8	2 1/8	2 5/8	1 3/8	1 3/8	1 5/8	1 5/8	1 5/8	1 1/8	1 1/8	1 3/8	1 3/8	1 3/8	50.00	600,000

- Refer to DuPont Refrigerant Expert, version 2.0. Suva 404A (R-404A) for actual velocities and pressure drops.
- Equivalent length is actual length plus friction losses caused by fittings and accessories.
- Line sizes are expressed in outside diameter of type “L” copper tubing.
- Line sizes are calculated at rated full load system capacity.
- All selections are based on a maximum of 65° F return gas entering the compressor and a refrigerant condensing and liquid line temperature of 105° F.



Suva 507
Refrigerant Piping Guide

Suva[®]
refrigerants

Suva 507 Pressure Drop in Lines
refer to page 14 (Suva 404A)

Suva 507 Velocity in Lines
refer to page 15 (Suva 404A)



The miracles of science™

Suva®
refrigerants

Refrigerant

Suva 95 (R-508B)

Piping Guide

From 12,000 BTU through 240,000 BTU per hour at -130° F through
-60° F saturated suction temperature. (1.0 ton through 20.0 tons)

" Quick Pick "

Note:

This data is for the selection of the second stage refrigeration piping of a typical cascade refrigeration system ONLY. In the first stage use Suva 404A (R-404A) refrigerant and select the suggested pipe size from the Suva 404A (R-404A) refrigerant piping guide.



Suva 95 Refrigerant Piping Guide



Suction Line Size .. Evaporator to Compressor

		- 60° F through -100° F (68 through 17 psig)					- 101° F through - 115° F (16 through 6 psig)					- 116° F through - 130° F (5 psig through 4" Hg)						
		Suggested Allowable Pressure Drop in psig = 2F°																
		2.6 lbs. (2F°)					1.4 lbs. (2F°)					1.0 lbs. (2F°)						
System Capacity BTU/Hr.	System Capacity Tons/Hr	Equivalent Suction Line Lengths ... feet															System Capacity Tons/Hr	System Capacity BTU/Hr.
		25	50	75	100	150	25	50	75	100	150	25	50	75	100	150		
12,000	1.00	3/4	3/4	7/8	7/8		3/4	7/8	1 1/8	1 1/8		1 1/8	1 1/8	1 1/8	1 3/8		1.00	12,000
18,000	1.50	7/8	7/8	7/8	1 1/8		7/8	1 1/8	1 1/8	1 1/8		1 1/8	1 3/8	1 3/8	1 3/8		1.50	18,000
24,000	2.00	7/8	1 1/8	1 1/8	1 1/8	N/A	1 1/8	1 1/8	1 3/8	1 3/8	N/A	1 1/8	1 3/8	1 5/8	1 5/8	N/A	2.00	24,000
30,000	2.50	7/8	1 1/8	1 1/8	1 1/8		1 1/8	1 3/8	1 3/8	1 3/8		1 3/8	1 5/8	1 5/8	1 5/8		2.50	30,000
36,000	3.00	1 1/8	1 1/8	1 1/8	1 3/8		1 1/8	1 3/8	1 5/8	1 5/8		1 3/8	1 5/8	2 1/8	2 1/8		3.00	36,000
42,000	3.50	1 1/8	1 1/8	1 3/8	1 3/8		1 3/8	1 3/8	1 5/8	1 5/8		1 3/8	1 5/8	2 1/8	2 1/8		3.50	42,000
48,000	4.00	1 1/8	1 3/8	1 3/8	1 3/8		1 3/8	1 5/8	1 5/8	1 5/8		1 5/8	2 1/8	2 1/8	2 1/8		4.00	48,000
60,000	5.00	1 1/8	1 3/8	1 3/8	1 5/8		1 3/8	1 5/8	2 1/8	2 1/8		1 5/8	2 1/8	2 1/8	2 1/8		5.00	60,000
92,000	7.50	1 3/8	1 5/8	1 5/8	1 5/8	N/A	1 5/8	2 1/8	2 1/8	2 1/8	N/A	2 1/8	2 1/8	2 5/8	2 5/8	N/A	7.50	92,000
120,000	10.00	1 5/8	1 5/8	2 1/8	2 1/8		2 1/8	2 1/8	2 5/8	2 5/8		2 1/8	2 5/8	2 5/8	2 5/8		10.00	120,000
180,000	15.00	1 5/8	2 1/8	2 1/8	2 1/8		2 1/8	2 5/8	2 5/8	2 5/8		2 5/8	3 1/8	3 1/8	3 1/8		15.00	180,000
240,000	20.00	2 1/8	2 1/8	2 5/8	2 5/8		2 5/8	2 5/8	3 1/8	3 1/8		2 5/8	3 1/8	3 5/8	3 5/8		20.00	240,000
300,000	25.00	N/A	N/A	N/A	N/A	N/A	N/A	N/A	N/A	N/A	N/A	N/A	N/A	N/A	N/A	N/A	25.00	300,000
360,000	30.00																30.00	360,000
420,000	35.00	N/A	N/A	N/A	N/A	N/A	N/A	N/A	N/A	N/A	N/A	N/A	N/A	N/A	N/A	N/A	35.00	420,000
480,000	40.00																40.00	480,000
540,000	45.00																45.00	540,000
600,000	50.00																50.00	600,000

- Refer to DuPont Refrigerant Expert, version 2.0 for actual velocities and pressure drops.
- Equivalent length is actual length plus friction losses caused by fittings and accessories.
- Line sizes are expressed in outside diameter of type “L” copper tubing.
- Line sizes are calculated at rated full load system capacity.
- All selections are based on a maximum of - 60° F return gas entering the compressor and a refrigerant condensing and liquid line temperature of - 20° F.



Suva 95 Refrigerant Piping Guide



		Discharge Line Size Compressor to Condenser <small>1F° (3.2 psi) pressure drop maximum</small>					Liquid Condensate Line Condenser to Receiver <small>Condensate drain / vent</small>					Liquid Line Size Receiver to TXV <small>1F° (3.4 psi) pressure drop maximum</small>						
System Capacity BTU/Hr.	System Capacity Tons/Hr	Equivalent Line Lengths ... feet															System Capacity Tons/Hr	System Capacity BTU/Hr.
		25	50	75	100	150	25	50	75	100	150	25	50	75	100	150		
12,000	1.00	1/2	5/8	5/8	5/8		1/2	1/2	1/2	1/2		3/8	3/8	3/8	3/8		1.00	12,000
18,000	1.50	5/8	3/4	3/4	3/4		1/2	1/2	5/8	5/8		3/8	3/8	1/2	1/2		1.50	18,000
24,000	2.00	5/8	3/4	7/8	7/8	N/A	5/8	5/8	5/8	5/8	N/A	1/2	1/2	1/2	1/2	N/A	2.00	24,000
30,000	2.50	3/4	3/4	7/8	7/8		5/8	5/8	5/8	3/4		1/2	1/2	1/2	5/8		2.50	30,000
36,000	3.00	3/4	7/8	7/8	1 1/8		5/8	5/8	3/4	3/4		1/2	1/2	5/8	5/8		3.00	36,000
42,000	3.50	3/4	7/8	1 1/8	1 1/8		5/8	5/8	3/4	3/4		1/2	1/2	5/8	5/8		3.50	42,000
48,000	4.00	7/8	1 1/8	1 1/8	1 1/8		5/8	3/4	3/4	3/4		1/2	5/8	5/8	5/8		4.00	48,000
60,000	5.00	7/8	1 1/8	1 1/8	1 1/8		5/8	3/4	3/4	7/8		1/2	5/8	5/8	3/4		5.00	60,000
92,000	7.50	1 1/8	1 1/8	1 3/8	1 3/8	N/A	3/4	7/8	7/8	7/8	N/A	5/8	3/4	3/4	3/4	N/A	7.50	92,000
120,000	10.00	1 1/8	1 3/8	1 3/8	1 5/8		7/8	7/8	1 1/8	1 1/8		3/4	3/4	7/8	7/8		10.00	120,000
180,000	15.00	1 3/8	1 5/8	1 5/8	2 1/8		7/8	1 1/8	1 3/8	1 3/8		3/4	7/8	1 1/8	1 1/8		15.00	180,000
240,000	20.00	1 5/8	2 1/8	2 1/8	2 1/8		1 1/8	1 3/8	1 3/8	1 3/8		7/8	1 1/8	1 1/8	1 1/8		20.00	240,000
300,000	25.00																25.00	300,000
360,000	30.00																30.00	360,000
420,000	35.00	N/A	N/A	N/A	N/A	N/A	N/A	N/A	N/A	N/A	N/A	N/A	N/A	N/A	N/A	N/A	35.00	420,000
480,000	40.00																40.00	480,000
540,000	45.00																45.00	540,000
600,000	50.00																50.00	600,000

- Refer to DuPont Refrigerant Expert, version 2.0 for actual velocities and pressure drops.
- Equivalent length is actual length plus friction losses caused by fittings and accessories.
- Line sizes are expressed in outside diameter of type “L” copper tubing.
- Line sizes are calculated at rated full load system capacity.
- All selections are based on a maximum of - 60° F return gas entering the compressor and a refrigerant condensing and liquid line temperature of - 20° F.



The miracles of science™

HCFC "Quick Pick"

Section 9



The miracles of science™

Suva®
refrigerants

HCFC Refrigerant

" Quick Pick "

Handbook



HCFC " Quick Pick " ... Section Nine

R-22 Quick Pick	page 3
R-124 Quick Pick	page 9
R-401A Quick Pick	page 12
R-402A Quick Pick	page 16



The miracles of science™

Suva[®]
refrigerants

Refrigerant

Freon 22 (R-22)

Piping Guide

From 18,000 BTU through 600,000 BTU per hour at -50° F through +50° F saturated suction temperature. (1.5 ton through 50.0 tons)

“Quick Pick”



Freon 22 Refrigerant Piping Guide



Suction Line Size .. Evaporator to Compressor

		50° F through 30° F (84 through 55 psig)					29° F through 10° F (54 through 33 psig)					9° F through -10° F (32 through 16 psig)						
		Suggested Allowable Pressure Drop in psig = 2F°																
		2.9 lbs. (2F°)					2.2 lbs. (2F°)					1.7 lbs. (2F°)						
System Capacity BTU/Hr.	System Capacity Tons/Hr	Equivalent Suction Line Lengths ... feet															System Capacity Tons/Hr	System Capacity BTU/Hr.
		25	50	75	100	150	25	50	75	100	150	25	50	75	100	150		
18,000	1.50	5/8	3/4	3/4	3/4	7/8	3/4	3/4	7/8	7/8	1 1/8	3/4	7/8	1 1/8	1 1/8	1 1/8	1.50	18,000
24,000	2.00	5/8	3/4	3/4	7/8	7/8	3/4	7/8	7/8	1 1/8	1 1/8	7/8	1 1/8	1 1/8	1 1/8	1 3/8	2.00	24,000
30,000	2.50	3/4	7/8	7/8	7/8	1 1/8	7/8	7/8	1 1/8	1 1/8	1 1/8	7/8	1 1/8	1 1/8	1 1/8	1 3/8	2.50	30,000
36,000	3.00	3/4	7/8	7/8	1 1/8	1 1/8	7/8	1 1/8	1 1/8	1 1/8	1 1/8	1 1/8	1 1/8	1 3/8	1 3/8	1 3/8	3.00	36,000
42,000	3.50	3/4	7/8	1 1/8	1 1/8	1 1/8	7/8	1 1/8	1 1/8	1 1/8	1 3/8	1 1/8	1 1/8	1 3/8	1 3/8	1 5/8	3.50	42,000
48,000	4.00	7/8	1 1/8	1 1/8	1 1/8	1 1/8	1 1/8	1 1/8	1 1/8	1 3/8	1 3/8	1 1/8	1 3/8	1 3/8	1 3/8	1 5/8	4.00	48,000
60,000	5.00	7/8	1 1/8	1 1/8	1 1/8	1 3/8	1 1/8	1 1/8	1 3/8	1 3/8	1 3/8	1 1/8	1 3/8	1 3/8	1 5/8	1 5/8	5.00	60,000
92,000	7.50	1 1/8	1 1/8	1 3/8	1 3/8	1 3/8	1 1/8	1 3/8	1 3/8	1 5/8	1 5/8	1 3/8	1 5/8	1 5/8	2 1/8	2 1/8	7.50	92,000
120,000	10.00	1 1/8	1 3/8	1 3/8	1 5/8	1 5/8	1 3/8	1 5/8	1 5/8	1 5/8	2 1/8	1 5/8	1 5/8	2 1/8	2 1/8	2 1/8	10.00	120,000
150,000	12.50	1 3/8	1 3/8	1 5/8	1 5/8	2 1/8	1 3/8	1 5/8	2 1/8	2 1/8	2 1/8	1 5/8	2 1/8	2 1/8	2 1/8	2 5/8	12.50	150,000
180,000	15.00	1 3/8	1 5/8	1 5/8	2 1/8	2 1/8	1 5/8	2 1/8	2 1/8	2 1/8	2 1/8	2 1/8	2 1/8	2 1/8	2 5/8	2 5/8	15.00	180,000
240,000	20.00	1 3/8	1 5/8	2 1/8	2 1/8	2 1/8	1 5/8	2 1/8	2 1/8	2 1/8	2 5/8	2 1/8	2 1/8	2 5/8	2 5/8	2 5/8	20.00	240,000
300,000	25.00	1 5/8	2 1/8	2 1/8	2 1/8	2 1/8	2 1/8	2 1/8	2 5/8	2 5/8	2 5/8	2 1/8	2 5/8	2 5/8	2 5/8	3 1/8	25.00	300,000
360,000	30.00	1 5/8	2 1/8	2 1/8	2 1/8	2 5/8	2 1/8	2 1/8	2 5/8	2 5/8	2 5/8	2 5/8	2 5/8	2 5/8	3 1/8	3 1/8	30.00	360,000
420,000	35.00	2 1/8	2 1/8	2 5/8	2 5/8	2 5/8	2 1/8	2 5/8	2 5/8	2 5/8	3 1/8	2 5/8	2 5/8	3 1/8	3 1/8	3 5/8	35.00	420,000
480,000	40.00	2 1/8	2 1/8	2 5/8	2 5/8	2 5/8	2 1/8	2 5/8	2 5/8	3 1/8	3 1/8	2 5/8	3 1/8	3 1/8	3 5/8	3 5/8	40.00	480,000
540,000	45.00	2 1/8	2 5/8	2 5/8	2 5/8	3 1/8	2 5/8	2 5/8	3 1/8	3 1/8	3 1/8	2 5/8	3 1/8	3 1/8	3 5/8	3 5/8	45.00	540,000
600,000	50.00	2 1/8	2 5/8	2 5/8	2 5/8	3 1/8	2 5/8	2 5/8	3 1/8	3 1/8	3 5/8	2 5/8	3 1/8	3 1/8	3 5/8	3 5/8	50.00	600,000

- Refer to DuPont Refrigerant Expert, version 2.0 for actual velocities and pressure drops.
- Equivalent length is actual length plus friction losses caused by fittings and accessories.
- Line sizes are expressed in outside diameter of type “L” copper tubing.
- Line sizes are calculated at rated full load system capacity.
- All selections are based on a maximum of 65° F return gas entering the compressor and a refrigerant condensing and liquid line temperature of 105° F.



Freon 22 Refrigerant Piping Guide



Suction Line Size .. Evaporator to Compressor

		- 11° F through - 30° F (16 through 5 psig)					- 31° F through - 50° F (4 psig through 7" Hg)						
		1.1 lbs. (2F°)					0.8 lbs. (2F°)						
System Capacity BTU/Hr.	System Capacity Tons/Hr	Equivalent Suction Lengths ... feet										System Capacity Tons/Hr	System Capacity BTU/Hr.
		25	50	75	100	150	25	50	75	100	150		
18,000	1.50	7/8	1 1/8	1 1/8	1 3/8	1 3/8	1 1/8	1 3/8	1 3/8	1 3/8	1 5/8	1.50	18,000
24,000	2.00	1 1/8	1 1/8	1 3/8	1 3/8	1 3/8	1 3/8	1 3/8	1 5/8	1 5/8	1 5/8	2.00	24,000
30,000	2.50	1 1/8	1 3/8	1 3/8	1 5/8	1 5/8	1 3/8	1 5/8	1 5/8	1 5/8	2 1/8	2.50	30,000
36,000	3.00	1 1/8	1 3/8	1 3/8	1 5/8	1 5/8	1 3/8	1 5/8	1 5/8	2 1/8	2 1/8	3.00	36,000
42,000	3.50	1 3/8	1 3/8	1 5/8	2 1/8	2 1/8	1 5/8	1 5/8	2 1/8	2 1/8	2 1/8	3.50	42,000
48,000	4.00	1 3/8	1 5/8	1 5/8	2 1/8	2 1/8	1 5/8	2 1/8	2 1/8	2 1/8	2 1/8	4.00	48,000
60,000	5.00	1 3/8	1 5/8	2 1/8	2 1/8	2 1/8	1 5/8	2 1/8	2 1/8	2 1/8	2 5/8	5.00	60,000
92,000	7.50	1 5/8	2 1/8	2 1/8	2 1/8	2 5/8	2 1/8	2 1/8	2 5/8	2 5/8	2 5/8	7.50	92,000
120,000	10.00	2 1/8	2 1/8	2 1/8	2 5/8	2 5/8	2 1/8	2 5/8	2 5/8	2 5/8	3 1/8	10.00	120,000
150,000	12.50	2 1/8	2 1/8	2 5/8	2 5/8	3 1/8	2 5/8	2 5/8	3 1/8	3 1/8	3 5/8	12.50	150,000
180,000	15.00	2 1/8	2 5/8	2 5/8	2 5/8	3 1/8	2 5/8	3 1/8	3 1/8	3 1/8	3 5/8	15.00	180,000
240,000	20.00	2 5/8	2 5/8	3 1/8	3 1/8	3 5/8	2 5/8	3 1/8	3 5/8	3 5/8	4 1/8	20.00	240,000
300,000	25.00	2 5/8	3 1/8	3 1/8	3 5/8	3 5/8	3 1/8	3 5/8	3 5/8	3 5/8	4 1/8	25.00	300,000
360,000	30.00	2 5/8	3 1/8	3 5/8	3 5/8	4 1/8	3 1/8	3 5/8	3 5/8	4 1/8	5 1/8	30.00	360,000
420,000	35.00	3 1/8	3 5/8	3 5/8	3 5/8	4 1/8	3 5/8	4 1/8	4 1/8	5 1/8	5 1/8	35.00	420,000
480,000	40.00	3 1/8	3 5/8	3 5/8	4 1/8	4 1/8	3 5/8	4 1/8	5 1/8	5 1/8	5 1/8	40.00	480,000
540,000	45.00	3 1/8	3 5/8	4 1/8	4 1/8	5 1/8	3 5/8	4 1/8	5 1/8	5 1/8	5 1/8	45.00	540,000
600,000	50.00	3 5/8	3 5/8	4 1/8	4 1/8	5 1/8	4 1/8	5 1/8	5 1/8	5 1/8	6 1/8	50.00	600,000

- Refer to DuPont Refrigerant Expert, version 2.0 for actual velocities and pressure drops.
- Equivalent length is actual length plus friction losses caused by fittings and accessories.
- Line sizes are expressed in outside diameter of type "L" copper tubing.
- Line sizes are calculated at rated full load system capacity.
- All selections are based on a maximum of 65° F return gas entering the compressor and a refrigerant condensing and liquid line temperature of 105° F.



Freon 22 Refrigerant Piping Guide



		Discharge Line Size Compressor to Condenser <small>1F° (3 psi) pressure drop maximum</small>					Liquid Condensate Line Condenser to Receiver <small>Condensate drain / vent</small>					Liquid Line Size Receiver to TXV <small>1F° (3 psi) pressure drop maximum</small>						
System Capacity BTU/Hr.	System Capacity Tons/Hr	Equivalent Line Lengths ... feet															System Capacity Tons/Hr	System Capacity BTU/Hr.
		25	50	75	100	150	25	50	75	100	150	25	50	75	100	150		
18,000	1.50	1/2	5/8	5/8	5/8	3/4	1/2	1/2	1/2	1/2	5/8	3/8	3/8	3/8	3/8	1/2	1.50	18,000
24,000	2.00	5/8	5/8	3/4	3/4	3/4	1/2	1/2	1/2	5/8	5/8	3/8	3/8	3/8	1/2	1/2	2.00	24,000
30,000	2.50	5/8	3/4	3/4	3/4	7/8	1/2	1/2	5/8	5/8	5/8	3/8	3/8	1/2	1/2	1/2	2.50	30,000
36,000	3.00	3/4	3/4	3/4	7/8	7/8	1/2	5/8	5/8	5/8	5/8	3/8	1/2	1/2	1/2	1/2	3.00	36,000
42,000	3.50	3/4	3/4	7/8	7/8	7/8	5/8	5/8	5/8	5/8	3/4	1/2	1/2	1/2	1/2	5/8	3.50	42,000
48,000	4.00	3/4	3/4	7/8	7/8	1 1/8	5/8	5/8	5/8	3/4	3/4	1/2	1/2	1/2	5/8	5/8	4.00	48,000
60,000	5.00	3/4	7/8	7/8	1 1/8	1 1/8	5/8	5/8	3/4	3/4	3/4	1/2	1/2	5/8	5/8	5/8	5.00	60,000
92,000	7.50	7/8	1 1/8	1 1/8	1 1/8	1 3/8	3/4	3/4	3/4	7/8	7/8	5/8	5/8	5/8	3/4	3/4	7.50	92,000
120,000	10.00	1 1/8	1 1/8	1 1/8	1 3/8	1 3/8	3/4	3/4	7/8	7/8	7/8	5/8	5/8	3/4	3/4	3/4	10.00	120,000
150,000	12.50	1 1/8	1 1/8	1 3/8	1 3/8	1 5/8	3/4	7/8	7/8	7/8	1 1/8	5/8	3/4	3/4	3/4	7/8	12.50	150,000
180,000	15.00	1 1/8	1 3/8	1 3/8	1 3/8	1 5/8	7/8	7/8	1 1/8	1 1/8	1 1/8	3/4	3/4	7/8	7/8	7/8	15.00	180,000
240,000	20.00	1 3/8	1 3/8	1 5/8	1 5/8	2 1/8	7/8	1 1/8	1 1/8	1 3/8	1 3/8	3/4	7/8	7/8	1 1/8	1 1/8	20.00	240,000
300,000	25.00	1 3/8	1 5/8	1 5/8	2 1/8	2 1/8	1 1/8	1 1/8	1 3/8	1 3/8	1 3/8	7/8	7/8	1 1/8	1 1/8	1 1/8	25.00	300,000
360,000	30.00	1 3/8	1 5/8	2 1/8	2 1/8	2 1/8	1 1/8	1 3/8	1 3/8	1 3/8	1 3/8	7/8	1 1/8	1 1/8	1 1/8	1 1/8	30.00	360,000
420,000	35.00	1 5/8	1 5/8	2 1/8	2 1/8	2 1/8	1 1/8	1 3/8	1 3/8	1 3/8	1 5/8	7/8	1 1/8	1 1/8	1 1/8	1 3/8	35.00	420,000
480,000	40.00	1 5/8	2 1/8	2 1/8	2 1/8	2 1/8	1 3/8	1 3/8	1 3/8	1 3/8	1 5/8	1 1/8	1 1/8	1 1/8	1 1/8	1 3/8	40.00	480,000
540,000	45.00	2 1/8	2 1/8	2 1/8	2 1/8	2 5/8	1 3/8	1 3/8	1 3/8	1 5/8	1 5/8	1 1/8	1 1/8	1 1/8	1 3/8	1 3/8	45.00	540,000
600,000	50.00	2 1/8	2 1/8	2 1/8	2 1/8	2 5/8	1 3/8	1 3/8	1 5/8	1 5/8	1 5/8	1 1/8	1 1/8	1 3/8	1 3/8	1 3/8	50.00	600,000

- Refer to DuPont Refrigerant Expert, version 2.0 for actual velocities and pressure drops.
- Equivalent length is actual length plus friction losses caused by fittings and accessories.
- Line sizes are expressed in outside diameter of type “L” copper tubing.
- Line sizes are calculated at rated full load system capacity.
- All selections are based on a maximum of 65° F return gas entering the compressor and a refrigerant condensing and liquid line temperature of 105° F.

FREON "22" REFRIGERANT PRESSURE DROP IN LINES (65°F Evap. Outlet)

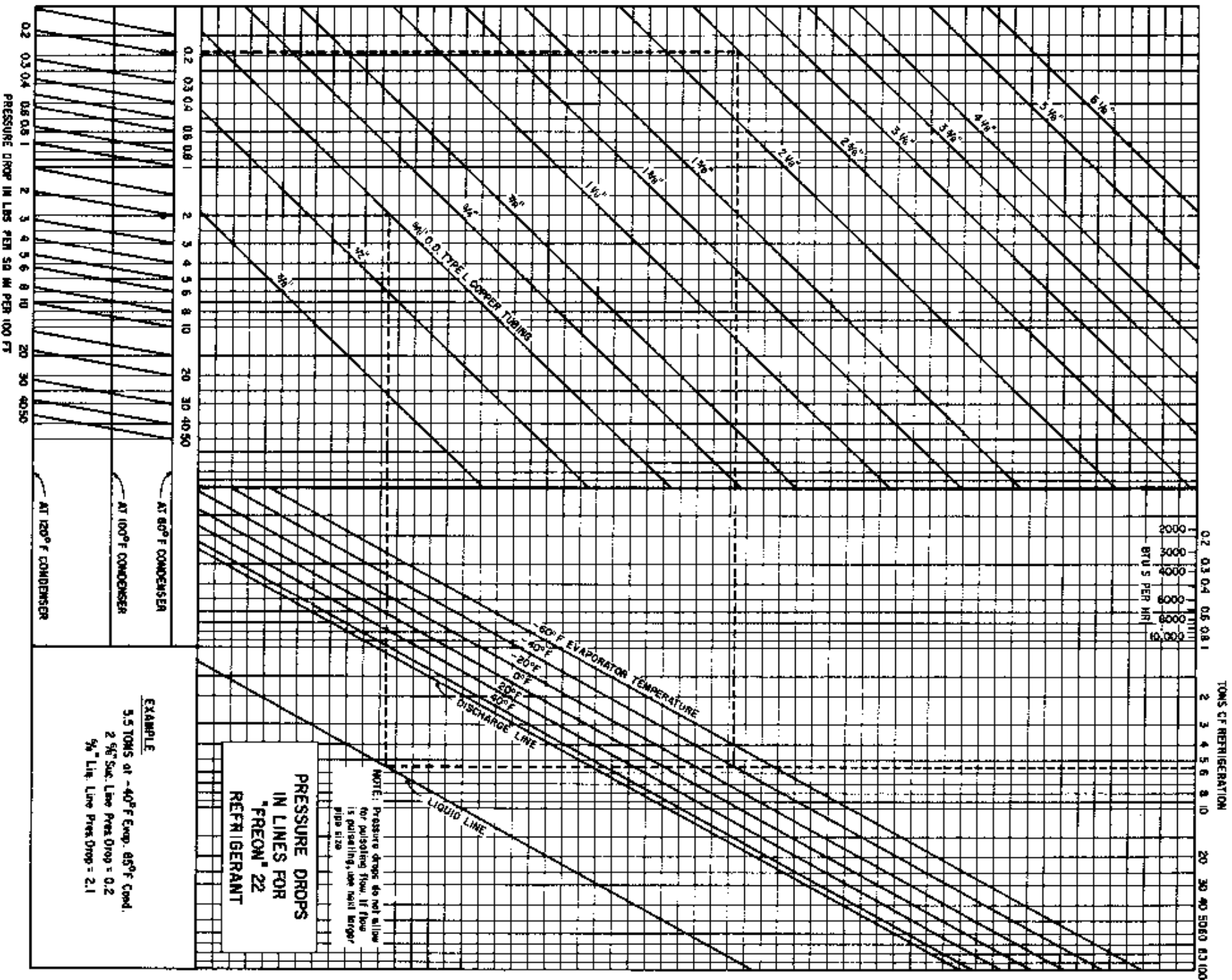

FREON "22" REFRIGERANT VELOCITY IN LINES (65°F Evap. Outlet)

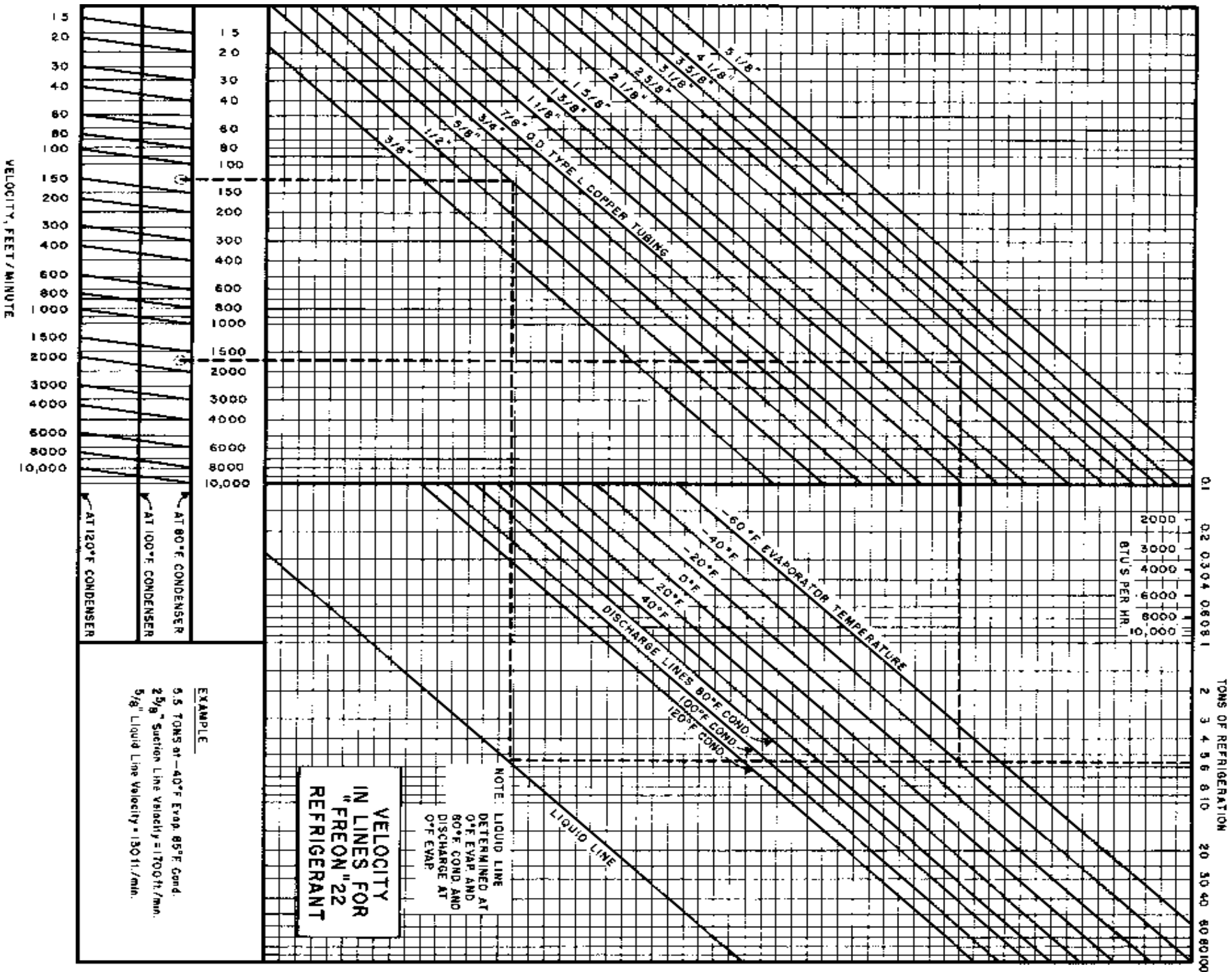



The miracles of science™

Suva[®]
refrigerants

Refrigerant

Suva 124 (R-124)

Piping Guide

From 18,000 BTU through 240,000 BTU per hour at -10° F through + 50° F saturated suction temperature. (1.5 ton through 20.0 tons)

“Quick Pick”



Suva 124 Refrigerant Piping Guide



Suction Line Size .. Evaporator to Compressor

		50° F through 30° F (19 through 8 psig)					29° F through 10° F (8 through 0 psig)					9° F through -10° F (1" Hg through 11" Hg)						
		Suggested Allowable Pressure Drop in psig = 2F°																
		1.1 lbs. (2F°)					0.8 lbs. (2F°)					0.5 lbs. (2F°)						
System Capacity BTU/Hr.	System Capacity Tons/Hr	Equivalent Suction Line Lengths ... feet															System Capacity Tons/Hr	System Capacity BTU/Hr.
		25	50	75	100	150	25	50	75	100	150	25	50	75	100	150		
18,000	1.50	7/8	1 1/8	1 1/8	1 1/8		1 1/8	1 3/8	1 3/8	1 3/8		1 3/8	1 3/8	1 5/8	1 5/8		1.50	18,000
24,000	2.00	1 1/8	1 1/8	1 3/8	1 3/8		1 1/8	1 3/8	1 5/8	1 5/8		1 3/8	1 5/8	1 5/8	2 1/8		2.00	24,000
30,000	2.50	1 1/8	1 3/8	1 3/8	1 3/8	N/A	1 3/8	1 5/8	1 5/8	1 5/8	N/A	1 5/8	2 1/8	2 1/8	2 1/8	N/A	2.50	30,000
36,000	3.00	1 1/8	1 3/8	1 3/8	1 5/8		1 3/8	1 5/8	1 5/8	2 1/8		1 5/8	2 1/8	2 1/8	2 1/8		3.00	36,000
42,000	3.50	1 3/8	1 3/8	1 5/8	1 5/8		1 3/8	1 5/8	2 1/8	2 1/8		1 5/8	2 1/8	2 1/8	2 1/8		3.50	42,000
48,000	4.00	1 3/8	1 3/8	1 5/8	1 5/8		1 5/8	2 1/8	2 1/8	2 1/8		2 1/8	2 1/8	2 1/8	2 5/8		4.00	48,000
60,000	5.00	1 3/8	1 5/8	1 5/8	2 1/8		1 5/8	2 1/8	2 1/8	2 1/8		2 1/8	2 1/8	2 5/8	2 5/8		5.00	60,000
92,000	7.50	1 5/8	2 1/8	2 1/8	2 1/8		2 1/8	2 1/8	2 5/8	2 5/8		2 5/8	2 5/8	2 5/8	3 1/8		7.50	92,000
120,000	10.00	2 1/8	2 1/8	2 1/8	2 1/8	N/A	2 1/8	2 5/8	2 5/8	2 5/8	N/A	2 5/8	3 1/8	3 1/8	3 1/8	N/A	10.00	120,000
150,000	12.50	2 1/8	2 1/8	2 5/8	2 5/8		2 5/8	3 1/8	3 1/8	3 1/8		2 5/8	3 1/8	3 5/8	3 5/8		12.50	150,000
180,000	15.00	2 1/8	2 5/8	2 5/8	2 5/8		2 5/8	3 1/8	3 1/8	3 1/8		3 1/8	3 5/8	3 5/8	3 5/8		15.00	180,000
240,000	20.00	2 5/8	2 5/8	2 5/8	3 1/8		2 5/8	3 1/8	3 5/8	3 5/8		3 1/8	3 5/8	4 1/8	4 1/8		20.00	240,000
300,000	25.00																25.00	300,000
360,000	30.00																30.00	360,000
420,000	35.00	N/A	N/A	N/A	N/A	N/A	N/A	N/A	N/A	N/A	N/A	N/A	N/A	N/A	N/A	N/A	35.00	420,000
480,000	40.00																40.00	480,000
540,000	45.00																45.00	540,000
600,000	50.00																50.00	600,000

- Refer to DuPont Refrigerant Expert, version 2.0 for actual velocities and pressure drops.
- Equivalent length is actual length plus friction losses caused by fittings and accessories.
- Line sizes are expressed in outside diameter of type “L” copper tubing.
- Line sizes are calculated at rated full load system capacity.
- All selections are based on a maximum of 65° F return gas entering the compressor and a refrigerant condensing and liquid line temperature of 105° F.



Suva 124 Refrigerant Piping Guide



		Discharge Line Size Compressor to Condenser <small>1F° (1.4 psi) pressure drop maximum</small>					Liquid Condensate Line Condenser to Receiver <small>Condensate drain / vent</small>					Liquid Line Size Receiver to TXV <small>1F° (1.4 psi) pressure drop maximum</small>						
System Capacity BTU/Hr.	System Capacity Tons/Hr	Equivalent Line Lengths ... feet															System Capacity Tons/Hr	System Capacity BTU/Hr.
		25	50	75	100	150	25	50	75	100	150	25	50	75	100	150		
18,000	1.50	3/4	3/4	7/8	7/8		1/2	5/8	5/8	5/8		3/8	1/2	1/2	1/2		1.50	18,000
24,000	2.00	3/4	7/8	1 1/8	1 1/8		5/8	5/8	5/8	5/8		1/2	1/2	1/2	1/2		2.00	24,000
30,000	2.50	7/8	1 1/8	1 1/8	1 1/8	N/A	5/8	5/8	3/4	3/4	N/A	1/2	1/2	5/8	5/8	N/A	2.50	30,000
36,000	3.00	7/8	1 1/8	1 1/8	1 1/8		5/8	3/4	3/4	3/4		1/2	5/8	5/8	5/8		3.00	36,000
42,000	3.50	1 1/8	1 1/8	1 1/8	1 3/8		5/8	3/4	3/4	3/4		1/2	5/8	5/8	5/8		3.50	42,000
48,000	4.00	1 1/8	1 1/8	1 3/8	1 3/8		5/8	3/4	3/4	7/8		1/2	5/8	5/8	3/4		4.00	48,000
60,000	5.00	1 1/8	1 3/8	1 3/8	1 3/8		3/4	3/4	7/8	7/8		5/8	5/8	3/4	3/4		5.00	60,000
92,000	7.50	1 3/8	1 3/8	1 5/8	1 5/8		3/4	7/8	7/8	1 1/8		5/8	3/4	3/4	7/8		7.50	92,000
120,000	10.00	1 3/8	1 5/8	2 1/8	2 1/8	N/A	7/8	1 1/8	1 1/8	1 1/8	N/A	3/4	7/8	7/8	7/8	N/A	10.00	120,000
150,000	12.50	1 5/8	1 5/8	2 1/8	2 1/8		7/8	1 1/8	1 3/8	1 3/8		3/4	7/8	1 1/8	1 1/8		12.50	150,000
180,000	15.00	1 5/8	2 1/8	2 1/8	2 1/8		1 1/8	1 3/8	1 3/8	1 3/8		7/8	1 1/8	1 1/8	1 1/8		15.00	180,000
240,000	20.00	2 1/8	2 1/8	2 5/8	2 5/8		1 1/8	1 3/8	1 3/8	1 3/8		7/8	1 1/8	1 1/8	1 3/8		20.00	240,000
300,000	25.00																25.00	300,000
360,000	30.00																30.00	360,000
420,000	35.00	N/A	N/A	N/A	N/A	N/A	N/A	N/A	N/A	N/A	N/A	N/A	N/A	N/A	N/A	N/A	35.00	420,000
480,000	40.00																40.00	480,000
540,000	45.00																45.00	540,000
600,000	50.00																50.00	600,000

- Refer to DuPont Refrigerant Expert, version 2.0 for actual velocities and pressure drops.
- Equivalent length is actual length plus friction losses caused by fittings and accessories.
- Line sizes are expressed in outside diameter of type “L” copper tubing.
- Line sizes are calculated at rated full load system capacity.
- All selections are based on a maximum of 65° F return gas entering the compressor and a refrigerant condensing and liquid line temperature of 105° F.



The miracles of science™

Suva[®]
refrigerants

Refrigerant

Suva 401A (R-401A)

Piping Guide

From 18,000 BTU through 600,000 BTU per hour at -30° F through + 50° F saturated suction temperature. (1.5 ton through 50.0 tons)

“Quick Pick”



Suva 401A Refrigerant Piping Guide



Suction Line Size .. Evaporator to Compressor

		50° F through 30° F (46 through 27 psig)					29° F through 10° F (26 through 13 psig)					9° F through -10° F (11 through 2 psig)						
		Suggested Allowable Pressure Drop in psig = 2F°																
		2.0 lbs. (2F°)					1.4 lbs. (2F°)					1.0 lbs. (2F°)						
System Capacity BTU/Hr.	System Capacity Tons/Hr	Equivalent Suction Line Lengths ... feet															System Capacity Tons/Hr	System Capacity BTU/Hr.
		25	50	75	100	150	25	50	75	100	150	25	50	75	100	150		
18,000	1.50	3/4	3/4	7/8	7/8	1 1/8	3/4	7/8	1 1/8	1 1/8	1 1/8	1 1/8	1 1/8	1 1/8	1 3/8	1 3/8	1.50	18,000
24,000	2.00	3/4	7/8	7/8	1 1/8	1 1/8	7/8	1 1/8	1 1/8	1 1/8	1 1/8	1 1/8	1 1/8	1 3/8	1 3/8	2.00	24,000	
30,000	2.50	7/8	1 1/8	1 1/8	1 1/8	1 1/8	7/8	1 1/8	1 1/8	1 1/8	1 3/8	1 1/8	1 3/8	1 3/8	1 5/8	2.50	30,000	
36,000	3.00	7/8	1 1/8	1 1/8	1 1/8	1 3/8	1 1/8	1 1/8	1 3/8	1 3/8	1 3/8	1 1/8	1 3/8	1 3/8	1 5/8	3.00	36,000	
42,000	3.50	7/8	1 1/8	1 1/8	1 1/8	1 3/8	1 1/8	1 1/8	1 3/8	1 3/8	1 3/8	1 3/8	1 3/8	1 5/8	1 5/8	3.50	42,000	
48,000	4.00	1 1/8	1 1/8	1 3/8	1 3/8	1 3/8	1 1/8	1 3/8	1 3/8	1 3/8	1 5/8	1 3/8	1 5/8	1 5/8	2 1/8	4.00	48,000	
60,000	5.00	1 1/8	1 3/8	1 3/8	1 3/8	1 5/8	1 1/8	1 3/8	1 3/8	1 5/8	1 5/8	1 3/8	1 5/8	2 1/8	2 1/8	5.00	60,000	
92,000	7.50	1 3/8	1 3/8	1 5/8	1 5/8	1 5/8	1 3/8	1 5/8	1 5/8	2 1/8	2 1/8	1 5/8	2 1/8	2 1/8	2 5/8	7.50	92,000	
120,000	10.00	1 3/8	1 5/8	1 5/8	2 1/8	2 1/8	1 5/8	1 5/8	2 1/8	2 1/8	2 1/8	2 1/8	2 1/8	2 5/8	2 5/8	10.00	120,000	
150,000	12.50	1 5/8	1 5/8	2 1/8	2 1/8	2 1/8	1 5/8	2 1/8	2 1/8	2 1/8	2 5/8	2 1/8	2 5/8	2 5/8	3 1/8	12.50	150,000	
180,000	15.00	1 5/8	2 1/8	2 1/8	2 1/8	2 1/8	2 1/8	2 1/8	2 1/8	2 5/8	2 5/8	2 1/8	2 5/8	2 5/8	3 1/8	15.00	180,000	
240,000	20.00	2 1/8	2 1/8	2 1/8	2 5/8	2 5/8	2 1/8	2 1/8	2 5/8	2 5/8	2 5/8	2 5/8	2 5/8	3 1/8	3 1/8	20.00	240,000	
300,000	25.00	2 1/8	2 1/8	2 5/8	2 5/8	2 5/8	2 1/8	2 5/8	2 5/8	2 5/8	3 1/8	2 5/8	3 1/8	3 1/8	3 5/8	25.00	300,000	
360,000	30.00	2 1/8	2 5/8	2 5/8	2 5/8	3 1/8	2 1/8	2 5/8	2 5/8	3 1/8	3 1/8	2 5/8	3 1/8	3 5/8	4 1/8	30.00	360,000	
420,000	35.00	2 1/8	2 5/8	2 5/8	3 1/8	3 1/8	2 5/8	2 5/8	3 1/8	3 1/8	3 5/8	3 1/8	3 5/8	3 5/8	4 1/8	35.00	420,000	
480,000	40.00	2 1/8	2 5/8	2 5/8	3 1/8	3 1/8	2 5/8	3 1/8	3 1/8	3 1/8	3 5/8	3 1/8	3 5/8	3 5/8	4 1/8	40.00	480,000	
540,000	45.00	2 5/8	2 5/8	3 1/8	3 1/8	3 5/8	2 5/8	3 1/8	3 1/8	3 5/8	3 5/8	3 1/8	3 5/8	4 1/8	5 1/8	45.00	540,000	
600,000	50.00	2 5/8	3 1/8	3 1/8	3 1/8	3 5/8	2 5/8	3 1/8	3 5/8	3 5/8	3 5/8	3 5/8	3 5/8	4 1/8	5 1/8	50.00	600,000	

- Refer to DuPont Refrigerant Expert, version 2.0 for actual velocities and pressure drops.
- Equivalent length is actual length plus friction losses caused by fittings and accessories.
- Line sizes are expressed in outside diameter of type “L” copper tubing.
- Line sizes are calculated at rated full load system capacity.
- All selections are based on a maximum of 65° F return gas entering the compressor and a refrigerant condensing and liquid line temperature of 105° F.



Suva 401A Refrigerant Piping Guide



Suction Line Size .. Evaporator to Compressor

		- 11° F through - 30° F (2 psig through 9" Hg)					- 31° F through - 50° F (10" through 18" Hg)						
		Suggested Allowable Pressure Drop in psig = 2F°											
		0.7 lbs. (2F°)					0.4 lbs. (2F°)						
System Capacity BTU/Hr.	System Capacity Tons/Hr	Equivalent Suction Lengths ... feet										System Capacity Tons/Hr	System Capacity BTU/Hr.
		25	50	75	100	150	25	50	75	100	150		
18,000	1.50	1 1/8	1 3/8	1 3/8	1 3/8	1 5/8						1.50	18,000
24,000	2.00	1 3/8	1 3/8	1 5/8	1 5/8	1 5/8						2.00	24,000
30,000	2.50	1 3/8	1 5/8	1 5/8	2 1/8	2 1/8	N/A	N/A	N/A	N/A	N/A	2.50	30,000
36,000	3.00	1 3/8	1 5/8	2 1/8	2 1/8	2 1/8						3.00	36,000
42,000	3.50	1 5/8	2 1/8	2 1/8	2 1/8	2 1/8						3.50	42,000
48,000	4.00	1 5/8	2 1/8	2 1/8	2 1/8	2 1/8						4.00	48,000
60,000	5.00	2 1/8	2 1/8	2 1/8	2 5/8	2 5/8						5.00	60,000
92,000	7.50	2 1/8	2 5/8	2 5/8	2 5/8	2 5/8						7.50	92,000
120,000	10.00	2 1/8	2 5/8	2 5/8	3 1/8	3 1/8	N/A	N/A	N/A	N/A	N/A	10.00	120,000
150,000	12.50	2 5/8	2 5/8	3 1/8	3 1/8	3 5/8						12.50	150,000
180,000	15.00	2 5/8	3 1/8	3 1/8	3 5/8	3 5/8						15.00	180,000
240,000	20.00	3 1/8	3 1/8	3 5/8	3 5/8	4 1/8						20.00	240,000
300,000	25.00	3 1/8	3 5/8	4 1/8	4 1/8	4 1/8						25.00	300,000
360,000	30.00	3 5/8	3 5/8	4 1/8	4 1/8	5 1/8						30.00	360,000
420,000	35.00	3 5/8	4 1/8	5 1/8	5 1/8	5 1/8	N/A	N/A	N/A	N/A	N/A	35.00	420,000
480,000	40.00	3 5/8	4 1/8	5 1/8	5 1/8	5 1/8						40.00	480,000
540,000	45.00	4 1/8	5 1/8	5 1/8	5 1/8	5 1/8						45.00	540,000
600,000	50.00	4 1/8	5 1/8	5 1/8	5 1/8	6 1/8						50.00	600,000

- Refer to DuPont Refrigerant Expert, version 2.0 for actual velocities and pressure drops.
- Equivalent length is actual length plus friction losses caused by fittings and accessories.
- Line sizes are expressed in outside diameter of type "L" copper tubing.
- Line sizes are calculated at rated full load system capacity.
- All selections are based on a maximum of 65° F return gas entering the compressor and a refrigerant condensing and liquid line temperature of 105° F.



Suva 401A Refrigerant Piping Guide



		Discharge Line Size Compressor to Condenser <small>1F° (2.2 psi) pressure drop maximum</small>					Liquid Condensate Line Condenser to Receiver <small>Condensate drain / vent</small>					Liquid Line Size Receiver to TXV <small>1F° (2.4 psi) pressure drop maximum</small>						
System Capacity BTU/Hr.	System Capacity Tons/Hr	Equivalent Line Lengths ... feet															System Capacity Tons/Hr	System Capacity BTU/Hr.
		25	50	75	100	150	25	50	75	100	150	25	50	75	100	150		
18,000	1.50	5/8	5/8	3/4	3/4	3/4	1/2	1/2	1/2	1/2	5/8	3/8	3/8	3/8	3/8	1/2	1.50	18,000
24,000	2.00	5/8	3/4	3/4	3/4	7/8	1/2	1/2	5/8	5/8	5/8	3/8	3/8	1/2	1/2	1/2	2.00	24,000
30,000	2.50	5/8	3/4	3/4	7/8	7/8	1/2	5/8	5/8	5/8	5/8	3/8	1/2	1/2	1/2	1/2	2.50	30,000
36,000	3.00	3/4	3/4	7/8	7/8	1 1/8	1/2	5/8	5/8	5/8	3/4	3/8	1/2	1/2	1/2	5/8	3.00	36,000
42,000	3.50	3/4	7/8	7/8	1 1/8	1 1/8	5/8	5/8	5/8	5/8	3/4	1/2	1/2	1/2	1/2	5/8	3.50	42,000
48,000	4.00	3/4	7/8	1 1/8	1 1/8	1 1/8	5/8	5/8	5/8	3/4	3/4	1/2	1/2	1/2	5/8	5/8	4.00	48,000
60,000	5.00	7/8	1 1/8	1 1/8	1 1/8	1 1/8	5/8	5/8	3/4	3/4	3/4	1/2	1/2	5/8	5/8	5/8	5.00	60,000
92,000	7.50	1 1/8	1 1/8	1 1/8	1 3/8	1 3/8	3/4	3/4	3/4	7/8	7/8	5/8	5/8	5/8	3/4	3/4	7.50	92,000
120,000	10.00	1 1/8	1 3/8	1 3/8	1 3/8	1 5/8	3/4	7/8	7/8	7/8	1 1/8	5/8	3/4	3/4	3/4	7/8	10.00	120,000
150,000	12.50	1 1/8	1 3/8	1 3/8	1 5/8	1 5/8	3/4	7/8	7/8	1 1/8	1 1/8	5/8	3/4	3/4	7/8	7/8	12.50	150,000
180,000	15.00	1 3/8	1 3/8	1 5/8	1 5/8	1 5/8	7/8	7/8	1 1/8	1 1/8	1 3/8	3/4	3/4	7/8	7/8	1 1/8	15.00	180,000
240,000	20.00	1 3/8	1 5/8	1 5/8	2 1/8	2 1/8	7/8	1 1/8	1 1/8	1 3/8	1 3/8	3/4	7/8	7/8	1 1/8	1 1/8	20.00	240,000
300,000	25.00	1 5/8	1 5/8	2 1/8	2 1/8	2 1/8	1 1/8	1 3/8	1 3/8	1 3/8	1 3/8	7/8	1 1/8	1 1/8	1 1/8	1 1/8	25.00	300,000
360,000	30.00	1 5/8	2 1/8	2 1/8	2 1/8	2 1/8	1 1/8	1 3/8	1 3/8	1 3/8	1 5/8	7/8	1 1/8	1 1/8	1 1/8	1 3/8	30.00	360,000
420,000	35.00	1 5/8	2 1/8	2 1/8	2 1/8	2 5/8	1 1/8	1 3/8	1 3/8	1 3/8	1 5/8	7/8	1 1/8	1 1/8	1 1/8	1 3/8	35.00	420,000
480,000	40.00	2 1/8	2 1/8	2 1/8	2 5/8	2 5/8	1 3/8	1 3/8	1 3/8	1 5/8	1 5/8	1 1/8	1 1/8	1 1/8	1 3/8	1 3/8	40.00	480,000
540,000	45.00	2 1/8	2 1/8	2 5/8	2 5/8	2 5/8	1 3/8	1 3/8	1 5/8	1 5/8	1 5/8	1 1/8	1 1/8	1 3/8	1 3/8	1 3/8	45.00	540,000
600,000	50.00	2 1/8	2 1/8	2 5/8	2 5/8	2 5/8	1 3/8	1 3/8	1 5/8	1 5/8	2 1/8	1 1/8	1 1/8	1 3/8	1 3/8	1 5/8	50.00	600,000

- Refer to DuPont Refrigerant Expert, version 2.0 for actual velocities and pressure drops.
- Equivalent length is actual length plus friction losses caused by fittings and accessories.
- Line sizes are expressed in outside diameter of type “L” copper tubing.
- Line sizes are calculated at rated full load system capacity.
- All selections are based on a maximum of 65° F return gas entering the compressor and a refrigerant condensing and liquid line temperature of 105° F.



The miracles of science™

Suva[®]
refrigerants

Refrigerant

Suva 402A (R-402A)

Piping Guide

From 18,000 BTU through 600,000 BTU per hour at -50° F through + 50° F saturated suction temperature. (1.5 ton through 50.0 tons)

“Quick Pick”



Suva 402A Refrigerant Piping Guide

Suction Line Size .. Evaporator to Compressor

		50° F through 30° F (110 through 74 psig)					29° F through 10° F (73 through 47 psig)					9° F through -10° F (45 through 26 psig)						
		Suggested Allowable Pressure Drop in psig = 2F°																
		3.6 lbs. (2F°)					2.7 lbs. (2F°)					2.0 lbs. (2F°)						
System Capacity BTU/Hr.	System Capacity Tons/Hr	Equivalent Suction Line Lengths ... feet															System Capacity Tons/Hr	System Capacity BTU/Hr.
		25	50	75	100	150	25	50	75	100	150	25	50	75	100	150		
18,000	1.50	5/8	3/4	3/4	3/4	7/8	3/4	3/4	7/8	7/8	1 1/8	3/4	7/8	1 1/8	1 1/8	1 1/8	1.50	18,000
24,000	2.00	5/8	3/4	7/8	7/8	7/8	3/4	7/8	1 1/8	1 1/8	1 1/8	7/8	1 1/8	1 1/8	1 1/8	1 3/8	2.00	24,000
30,000	2.50	3/4	7/8	7/8	7/8	1 1/8	7/8	1 1/8	1 1/8	1 1/8	1 1/8	1 1/8	1 1/8	1 1/8	1 3/8	1 3/8	2.50	30,000
36,000	3.00	3/4	7/8	1 1/8	1 1/8	1 1/8	7/8	1 1/8	1 1/8	1 1/8	1 3/8	1 1/8	1 1/8	1 3/8	1 3/8	1 3/8	3.00	36,000
42,000	3.50	7/8	7/8	1 1/8	1 1/8	1 1/8	7/8	1 1/8	1 1/8	1 3/8	1 3/8	1 1/8	1 3/8	1 3/8	1 3/8	1 5/8	3.50	42,000
48,000	4.00	7/8	1 1/8	1 1/8	1 1/8	1 1/8	1 1/8	1 1/8	1 1/8	1 3/8	1 3/8	1 1/8	1 3/8	1 3/8	1 5/8	1 5/8	4.00	48,000
60,000	5.00	7/8	1 1/8	1 1/8	1 1/8	1 3/8	1 1/8	1 3/8	1 3/8	1 3/8	1 5/8	1 3/8	1 3/8	1 5/8	1 5/8	2 1/8	5.00	60,000
92,000	7.50	1 1/8	1 3/8	1 3/8	1 3/8	1 5/8	1 3/8	1 3/8	1 5/8	1 5/8	1 5/8	1 3/8	1 5/8	2 1/8	2 1/8	2 1/8	7.50	92,000
120,000	10.00	1 1/8	1 3/8	1 3/8	1 5/8	1 5/8	1 3/8	1 5/8	1 5/8	2 1/8	2 1/8	1 5/8	2 1/8	2 1/8	2 1/8	2 1/8	10.00	120,000
150,000	12.50	1 3/8	1 3/8	1 5/8	1 5/8	2 1/8	1 5/8	1 5/8	2 1/8	2 1/8	2 1/8	1 5/8	2 1/8	2 1/8	2 1/8	2 5/8	12.50	150,000
180,000	15.00	1 3/8	1 5/8	1 5/8	2 1/8	2 1/8	1 5/8	2 1/8	2 1/8	2 1/8	2 1/8	2 1/8	2 1/8	2 1/8	2 5/8	2 5/8	15.00	180,000
240,000	20.00	1 5/8	1 5/8	2 1/8	2 1/8	2 1/8	2 1/8	2 1/8	2 1/8	2 5/8	2 5/8	2 1/8	2 5/8	2 5/8	2 5/8	3 1/8	20.00	240,000
300,000	25.00	1 5/8	2 1/8	2 1/8	2 1/8	2 5/8	2 1/8	2 1/8	2 5/8	2 5/8	2 5/8	2 1/8	2 5/8	2 5/8	3 1/8	3 1/8	25.00	300,000
360,000	30.00	2 1/8	2 1/8	2 1/8	2 5/8	2 5/8	2 1/8	2 5/8	2 5/8	2 5/8	3 1/8	2 5/8	2 5/8	3 1/8	3 1/8	3 5/8	30.00	360,000
420,000	35.00	2 1/8	2 1/8	2 5/8	2 5/8	2 5/8	2 1/8	2 5/8	2 5/8	2 5/8	3 1/8	2 5/8	3 1/8	3 1/8	3 1/8	3 5/8	35.00	420,000
480,000	40.00	2 1/8	2 1/8	2 5/8	2 5/8	2 5/8	2 1/8	2 5/8	2 5/8	3 1/8	3 1/8	2 5/8	3 1/8	3 1/8	3 5/8	3 5/8	40.00	480,000
540,000	45.00	2 1/8	2 5/8	2 5/8	2 5/8	3 1/8	2 5/8	2 5/8	3 1/8	3 1/8	3 5/8	2 5/8	3 1/8	3 5/8	3 5/8	4 1/8	45.00	540,000
600,000	50.00	2 1/8	2 5/8	2 5/8	2 5/8	3 1/8	2 5/8	2 5/8	3 1/8	3 1/8	3 5/8	3 1/8	3 1/8	3 5/8	3 5/8	4 1/8	50.00	600,000

- Refer to DuPont Refrigerant Expert, version 2.0 for actual velocities and pressure drops.
- Equivalent length is actual length plus friction losses caused by fittings and accessories.
- Line sizes are expressed in outside diameter of type “L” copper tubing.
- Line sizes are calculated at rated full load system capacity.
- All selections are based on a maximum of 65° F return gas entering the compressor and a refrigerant condensing and liquid line temperature of 105° F.



Suva 402A Refrigerant Piping Guide

Suction Line Size .. Evaporator to Compressor

		- 11° F through - 30° F (25 through 11 psig)					- 31° F through - 50° F (11 through 1 psig)						
		Suggested Allowable Pressure Drop in psig = 2F°											
		1.5 lbs. (2F°)					1.1 lbs. (2F°)						
System Capacity BTU/Hr.	System Capacity Tons/Hr	Equivalent Suction Lengths ... feet										System Capacity Tons/Hr	System Capacity BTU/Hr.
		25	50	75	100	150	25	50	75	100	150		
18,000	1.50	1 1/8	1 1/8	1 1/8	1 3/8	1 3/8	1 1/8	1 3/8	1 3/8	1 3/8	1 5/8	1.50	18,000
24,000	2.00	1 1/8	1 1/8	1 3/8	1 3/8	1 3/8	1 1/8	1 3/8	1 5/8	1 5/8	1 5/8	2.00	24,000
30,000	2.50	1 1/8	1 3/8	1 3/8	1 3/8	1 5/8	1 3/8	1 5/8	1 5/8	2 1/8	2 1/8	2.50	30,000
36,000	3.00	1 1/8	1 3/8	1 5/8	1 5/8	1 5/8	1 3/8	1 5/8	2 1/8	2 1/8	2 1/8	3.00	36,000
42,000	3.50	1 3/8	1 3/8	1 5/8	1 5/8	2 1/8	1 5/8	1 5/8	2 1/8	2 1/8	2 1/8	3.50	42,000
48,000	4.00	1 3/8	1 5/8	1 5/8	1 5/8	2 1/8	1 5/8	2 1/8	2 1/8	2 1/8	2 5/8	4.00	48,000
60,000	5.00	1 3/8	1 5/8	2 1/8	2 1/8	2 1/8	1 5/8	2 1/8	2 1/8	2 1/8	2 5/8	5.00	60,000
92,000	7.50	1 5/8	2 1/8	2 1/8	2 1/8	2 5/8	2 1/8	2 5/8	2 5/8	2 5/8	3 1/8	7.50	92,000
120,000	10.00	2 1/8	2 1/8	2 5/8	2 5/8	2 5/8	2 1/8	2 5/8	2 5/8	3 1/8	3 1/8	10.00	120,000
150,000	12.50	2 1/8	2 5/8	2 5/8	2 5/8	3 1/8	2 5/8	2 5/8	3 1/8	3 1/8	3 5/8	12.50	150,000
180,000	15.00	2 1/8	2 5/8	2 5/8	3 1/8	3 1/8	2 5/8	3 1/8	3 1/8	3 5/8	3 5/8	15.00	180,000
240,000	20.00	2 5/8	2 5/8	3 1/8	3 1/8	3 5/8	3 1/8	3 5/8	3 5/8	3 5/8	4 1/8	20.00	240,000
300,000	25.00	2 5/8	3 1/8	3 1/8	3 5/8	3 5/8	3 1/8	3 5/8	3 5/8	4 1/8	5 1/8	25.00	300,000
360,000	30.00	2 5/8	3 1/8	3 5/8	3 5/8	4 1/8	3 5/8	3 5/8	4 1/8	4 1/8	5 1/8	30.00	360,000
420,000	35.00	3 1/8	3 5/8	3 5/8	4 1/8	4 1/8	3 5/8	4 1/8	4 1/8	5 1/8	5 1/8	35.00	420,000
480,000	40.00	3 1/8	3 5/8	3 5/8	4 1/8	5 1/8	3 5/8	4 1/8	5 1/8	5 1/8	5 1/8	40.00	480,000
540,000	45.00	3 1/8	3 5/8	4 1/8	4 1/8	5 1/8	4 1/8	5 1/8	5 1/8	5 1/8	6 1/8	45.00	540,000
600,000	50.00	3 5/8	4 1/8	4 1/8	5 1/8	5 1/8	4 1/8	5 1/8	5 1/8	5 1/8	6 1/8	50.00	600,000

- Refer to DuPont Refrigerant Expert, version 2.0 for actual velocities and pressure drops.
- Equivalent length is actual length plus friction losses caused by fittings and accessories.
- Line sizes are expressed in outside diameter of type “L” copper tubing.
- Line sizes are calculated at rated full load system capacity.
- All selections are based on a maximum of 65° F return gas entering the compressor and a refrigerant condensing and liquid line temperature of 105° F.



Suva 402A Refrigerant Piping Guide



		Discharge Line Size Compressor to Condenser <small>1F° (3.7 psi) pressure drop maximum</small>					Liquid Condensate Line Condenser to Receiver <small>Condensate drain / vent</small>					Liquid Line Size Receiver to TXV <small>1F° (3.7 psi) pressure drop maximum</small>						
System Capacity BTU/Hr.	System Capacity Tons/Hr	Equivalent Line Lengths ... feet															System Capacity Tons/Hr	System Capacity BTU/Hr.
		25	50	75	100	150	25	50	75	100	150	25	50	75	100	150		
18,000	1.50	1/2	5/8	5/8	5/8	3/4	1/2	1/2	1/2	5/8	5/8	3/8	3/8	3/8	1/2	1/2	1.50	18,000
24,000	2.00	5/8	5/8	3/4	3/4	3/4	1/2	5/8	5/8	5/8	5/8	3/8	1/2	1/2	1/2	1/2	2.00	24,000
30,000	2.50	5/8	3/4	3/4	3/4	7/8	1/2	5/8	5/8	5/8	3/4	3/8	1/2	1/2	1/2	5/8	2.50	30,000
36,000	3.00	5/8	3/4	3/4	7/8	7/8	5/8	5/8	5/8	3/4	3/4	1/2	1/2	1/2	5/8	5/8	3.00	36,000
42,000	3.50	3/4	3/4	7/8	7/8	1 1/8	5/8	5/8	3/4	3/4	3/4	1/2	1/2	5/8	5/8	5/8	3.50	42,000
48,000	4.00	3/4	7/8	7/8	7/8	1 1/8	5/8	5/8	3/4	3/4	3/4	1/2	1/2	5/8	5/8	5/8	4.00	48,000
60,000	5.00	3/4	7/8	1 1/8	1 1/8	1 1/8	5/8	3/4	3/4	3/4	7/8	1/2	5/8	5/8	5/8	3/4	5.00	60,000
92,000	7.50	7/8	1 1/8	1 1/8	1 1/8	1 3/8	3/4	3/4	7/8	7/8	7/8	5/8	5/8	3/4	3/4	3/4	7.50	92,000
120,000	10.00	1 1/8	1 1/8	1 3/8	1 3/8	1 3/8	3/4	7/8	7/8	1 1/8	1 1/8	5/8	3/4	3/4	7/8	7/8	10.00	120,000
150,000	12.50	1 1/8	1 3/8	1 3/8	1 3/8	1 5/8	7/8	7/8	1 1/8	1 1/8	1 3/8	3/4	3/4	7/8	7/8	1 1/8	12.50	150,000
180,000	15.00	1 1/8	1 3/8	1 3/8	1 3/8	1 5/8	7/8	1 1/8	1 1/8	1 3/8	1 3/8	3/4	7/8	7/8	1 1/8	1 1/8	15.00	180,000
240,000	20.00	1 3/8	1 3/8	1 5/8	1 5/8	2 1/8	7/8	1 1/8	1 3/8	1 3/8	1 3/8	3/4	7/8	1 1/8	1 1/8	1 1/8	20.00	240,000
300,000	25.00	1 3/8	1 5/8	1 5/8	2 1/8	2 1/8	1 1/8	1 3/8	1 3/8	1 3/8	1 5/8	7/8	1 1/8	1 1/8	1 1/8	1 3/8	25.00	300,000
360,000	30.00	1 3/8	1 5/8	2 1/8	2 1/8	2 1/8	1 3/8	1 3/8	1 3/8	1 3/8	1 5/8	1 1/8	1 1/8	1 1/8	1 1/8	1 3/8	30.00	360,000
420,000	35.00	1 5/8	2 1/8	2 1/8	2 1/8	2 1/8	1 3/8	1 3/8	1 5/8	1 5/8	1 5/8	1 1/8	1 1/8	1 3/8	1 3/8	1 3/8	35.00	420,000
480,000	40.00	1 5/8	2 1/8	2 1/8	2 1/8	2 1/8	1 3/8	1 3/8	1 5/8	1 5/8	1 5/8	1 1/8	1 1/8	1 3/8	1 3/8	1 3/8	40.00	480,000
540,000	45.00	1 5/8	2 1/8	2 1/8	2 1/8	2 5/8	1 3/8	1 5/8	1 5/8	1 5/8	2 1/8	1 1/8	1 3/8	1 3/8	1 3/8	1 5/8	45.00	540,000
600,000	50.00	2 1/8	2 1/8	2 1/8	2 5/8	2 5/8	1 3/8	1 5/8	1 5/8	1 5/8	2 1/8	1 1/8	1 3/8	1 3/8	1 3/8	1 5/8	50.00	600,000

- Refer to DuPont Refrigerant Expert, version 2.0 for actual velocities and pressure drops.
- Equivalent length is actual length plus friction losses caused by fittings and accessories.
- Line sizes are expressed in outside diameter of type “L” copper tubing.
- Line sizes are calculated at rated full load system capacity.
- All selections are based on a maximum of 65° F return gas entering the compressor and a refrigerant condensing and liquid line temperature of 105° F.



The miracles of science™

CFC "Quick Pick"

Section 10



The miracles of science™

Suva[®]
refrigerants

CFC Refrigerant " Quick Pick " Handbook



CFC " Quick Pick " ... Section Nine

R-12 Quick Pick	page 3
R-13 Quick Pick	page 9
R-114 Quick Pick	page 12
R-500 Quick Pick	page 15
R-502 Quick Pick	page 19
R-503 Quick Pick	Page 25



The miracles of science™

Suva[®]
refrigerants

Refrigerant

Freon 12 (R-12)

Piping Guide

From 18,000 BTU through 600,000 BTU per hour at -30° F through + 50° F saturated suction temperature. (1.5 ton through 50.0 tons)

“Quick Pick”



Freon 12 Refrigerant Piping Guide

Suction Line Size .. Evaporator to Compressor

		50° F through 30° F (47 through 29 psig)					29° F through 10° F (28 through 15 psig)					9° F through -10° F (14 through 4.5 psig)							
		Suggested Allowable Pressure Drop in psig = 2F°																	
		1.9 lbs. (2F°)					1.3 lbs. (2F°)					1.0 lbs. (2F°)							
System Capacity BTU/Hr.	System Capacity Tons/Hr	Equivalent Suction Line Lengths ... feet															System Capacity Tons/Hr	System Capacity BTU/Hr.	
		25	50	75	100	150	25	50	75	100	150	25	50	75	100	150			
18,000	1.50	3/4	7/8	7/8	1 1/8	1 1/8	7/8	1 1/8	1 1/8	1 1/8	1 1/8	1 1/8	1 1/8	1 1/8	1 3/8	1 3/8	1 3/8	1.50	18,000
24,000	2.00	7/8	7/8	1 1/8	1 1/8	1 1/8	7/8	1 1/8	1 1/8	1 3/8	1 3/8	1 1/8	1 3/8	1 3/8	1 3/8	1 5/8	1 5/8	2.00	24,000
30,000	2.50	7/8	1 1/8	1 1/8	1 1/8	1 3/8	1 1/8	1 1/8	1 3/8	1 3/8	1 3/8	1 1/8	1 3/8	1 3/8	1 5/8	1 5/8	1 5/8	2.50	30,000
36,000	3.00	7/8	1 1/8	1 1/8	1 3/8	1 3/8	1 1/8	1 3/8	1 3/8	1 3/8	1 5/8	1 3/8	1 3/8	1 5/8	1 5/8	2 1/8	2 1/8	3.00	36,000
42,000	3.50	1 1/8	1 1/8	1 3/8	1 3/8	1 3/8	1 1/8	1 3/8	1 3/8	1 5/8	1 5/8	1 3/8	1 5/8	1 5/8	1 5/8	2 1/8	2 1/8	3.50	42,000
48,000	4.00	1 1/8	1 1/8	1 3/8	1 3/8	1 3/8	1 1/8	1 3/8	1 3/8	1 5/8	1 5/8	1 3/8	1 5/8	1 5/8	2 1/8	2 1/8	2 1/8	4.00	48,000
60,000	5.00	1 1/8	1 3/8	1 3/8	1 3/8	1 5/8	1 3/8	1 5/8	1 5/8	1 5/8	2 1/8	1 5/8	1 5/8	2 1/8	2 1/8	2 1/8	2 1/8	5.00	60,000
92,000	7.50	1 3/8	1 5/8	1 5/8	1 5/8	2 1/8	1 5/8	1 5/8	2 1/8	2 1/8	2 1/8	1 5/8	2 1/8	2 1/8	2 5/8	2 5/8	2 5/8	7.50	92,000
120,000	10.00	1 3/8	1 5/8	2 1/8	2 1/8	2 1/8	1 5/8	2 1/8	2 1/8	2 1/8	2 5/8	2 1/8	2 1/8	2 5/8	2 5/8	2 5/8	2 5/8	10.00	120,000
150,000	12.50	1 5/8	2 1/8	2 1/8	2 1/8	2 1/8	2 1/8	2 1/8	2 1/8	2 5/8	2 5/8	2 1/8	2 5/8	2 5/8	2 5/8	3 1/8	3 1/8	12.50	150,000
180,000	15.00	1 5/8	2 1/8	2 1/8	2 1/8	2 5/8	2 1/8	2 1/8	2 5/8	2 5/8	2 5/8	2 1/8	2 5/8	2 5/8	3 1/8	3 1/8	3 1/8	15.00	180,000
240,000	20.00	2 1/8	2 1/8	2 5/8	2 5/8	2 5/8	2 1/8	2 5/8	2 5/8	3 1/8	3 1/8	2 5/8	3 1/8	3 1/8	3 1/8	3 5/8	3 5/8	20.00	240,000
300,000	25.00	2 1/8	2 5/8	2 5/8	2 5/8	3 1/8	2 5/8	2 5/8	3 1/8	3 1/8	3 5/8	2 5/8	3 1/8	3 5/8	3 5/8	3 5/8	3 5/8	25.00	300,000
360,000	30.00	2 1/8	2 5/8	2 5/8	2 5/8	3 1/8	2 5/8	3 1/8	3 1/8	3 1/8	3 5/8	3 1/8	3 1/8	3 5/8	3 5/8	4 1/8	4 1/8	30.00	360,000
420,000	35.00	2 1/8	2 5/8	2 5/8	3 1/8	3 1/8	2 5/8	3 1/8	3 1/8	3 5/8	3 5/8	3 1/8	3 5/8	3 5/8	4 1/8	4 1/8	4 1/8	35.00	420,000
480,000	40.00	2 5/8	2 5/8	3 1/8	3 1/8	3 5/8	2 5/8	3 1/8	3 5/8	3 5/8	4 1/8	3 1/8	3 5/8	4 1/8	4 1/8	5 1/8	5 1/8	40.00	480,000
540,000	45.00	2 5/8	3 1/8	3 1/8	3 1/8	3 5/8	3 1/8	3 5/8	3 5/8	3 5/8	4 1/8	3 5/8	3 5/8	4 1/8	4 1/8	5 1/8	5 1/8	45.00	540,000
600,000	50.00	2 5/8	3 1/8	3 1/8	3 5/8	3 5/8	3 1/8	3 5/8	3 5/8	4 1/8	4 1/8	3 5/8	4 1/8	4 1/8	5 1/8	5 1/8	5 1/8	50.00	600,000

- Refer to DuPont Refrigerant Expert, version 2.0 for actual velocities and pressure drops.
- Equivalent length is actual length plus friction losses caused by fittings and accessories.
- Line sizes are expressed in outside diameter of type “L” copper tubing.
- Line sizes are calculated at rated full load system capacity.
- All selections are based on a maximum of 65° F return gas entering the compressor and a refrigerant condensing and liquid line temperature of 105° F.



Freon 12 Refrigerant Piping Guide

Suction Line Size .. Evaporator to Compressor

		- 11° F through - 30° F (4 psig through 6" Hg)					- 31° F through - 50° F (6" through 16" Hg)						
		Suggested Allowable Pressure Drop in psig = 2F°											
		0.7 lbs. (2F°)					0.5 lbs. (2F°)						
System Capacity BTU/Hr.	System Capacity Tons/Hr	Equivalent Suction Lengths ... feet										System Capacity Tons/Hr	System Capacity BTU/Hr.
		25	50	75	100	150	25	50	75	100	150		
18,000	1.50	1 1/8	1 3/8	1 3/8	1 5/8	1 5/8						1.50	18,000
24,000	2.00	1 3/8	1 5/8	1 5/8	1 5/8	2 1/8						2.00	24,000
30,000	2.50	1 3/8	1 5/8	2 1/8	2 1/8	2 1/8	N/A	N/A	N/A	N/A	N/A	2.50	30,000
36,000	3.00	1 5/8	1 5/8	2 1/8	2 1/8	2 1/8						3.00	36,000
42,000	3.50	1 5/8	2 1/8	2 1/8	2 1/8	2 1/8						3.50	42,000
48,000	4.00	1 5/8	2 1/8	2 1/8	2 1/8	2 5/8						4.00	48,000
60,000	5.00	2 1/8	2 1/8	2 1/8	2 5/8	2 5/8						5.00	60,000
92,000	7.50	2 1/8	2 5/8	2 5/8	2 5/8	3 1/8						7.50	92,000
120,000	10.00	2 5/8	2 5/8	3 1/8	3 1/8	3 1/8	N/A	N/A	N/A	N/A	N/A	10.00	120,000
150,000	12.50	2 5/8	3 1/8	3 1/8	3 1/8	3 5/8						12.50	150,000
180,000	15.00	2 5/8	3 1/8	3 1/8	3 5/8	3 5/8						15.00	180,000
240,000	20.00	3 1/8	3 5/8	3 5/8	3 5/8	4 1/8						20.00	240,000
300,000	25.00	3 1/8	3 5/8	4 1/8	4 1/8	5 1/8						25.00	300,000
360,000	30.00	3 5/8	4 1/8	4 1/8	5 1/8	5 1/8						30.00	360,000
420,000	35.00	3 5/8	4 1/8	5 1/8	5 1/8	5 1/8	N/A	N/A	N/A	N/A	N/A	35.00	420,000
480,000	40.00	4 1/8	5 1/8	5 1/8	5 1/8	5 1/8						40.00	480,000
540,000	45.00	4 1/8	5 1/8	5 1/8	5 1/8	5 1/8						45.00	540,000
600,000	50.00	4 1/8	5 1/8	5 1/8	5 1/8	6 1/8						50.00	600,000

- Refer to DuPont Refrigerant Expert, version 2.0 for actual velocities and pressure drops.
- Equivalent length is actual length plus friction losses caused by fittings and accessories.
- Line sizes are expressed in outside diameter of type "L" copper tubing.
- Line sizes are calculated at rated full load system capacity.
- All selections are based on a maximum of 65° F return gas entering the compressor and a refrigerant condensing and liquid line temperature of 105° F.



Freon 12 Refrigerant Piping Guide



		Discharge Line Size Compressor to Condenser <small>1F° (1.9 psi) pressure drop maximum</small>					Liquid Condensate Line Condenser to Receiver <small>Condensate drain / vent</small>					Liquid Line Size Receiver to TXV <small>1F° (1.9 psi) pressure drop maximum</small>						
System Capacity BTU/Hr.	System Capacity Tons/Hr	Equivalent Line Lengths ... feet															System Capacity Tons/Hr	System Capacity BTU/Hr.
		25	50	75	100	150	25	50	75	100	150	25	50	75	100	150		
18,000	1.50	5/8	3/4	3/4	3/4	7/8	1/2	1/2	5/8	5/8	5/8	3/8	3/8	1/2	1/2	1/2	1.50	18,000
24,000	2.00	3/4	3/4	7/8	7/8	1 1/8	1/2	5/8	5/8	5/8	3/4	3/8	1/2	1/2	1/2	5/8	2.00	24,000
30,000	2.50	3/4	7/8	7/8	1 1/8	1 1/8	5/8	5/8	5/8	3/4	3/4	1/2	1/2	1/2	5/8	5/8	2.50	30,000
36,000	3.00	3/4	7/8	1 1/8	1 1/8	1 1/8	5/8	5/8	3/4	3/4	3/4	1/2	1/2	5/8	5/8	5/8	3.00	36,000
42,000	3.50	7/8	1 1/8	1 1/8	1 1/8	1 1/8	5/8	5/8	3/4	3/4	3/4	1/2	1/2	5/8	5/8	5/8	3.50	42,000
48,000	4.00	7/8	1 1/8	1 1/8	1 1/8	1 3/8	5/8	3/4	3/4	3/4	3/4	7/8	1/2	5/8	5/8	3/4	4.00	48,000
60,000	5.00	1 1/8	1 1/8	1 1/8	1 3/8	1 3/8	3/4	3/4	3/4	7/8	7/8	5/8	5/8	5/8	3/4	3/4	5.00	60,000
92,000	7.50	1 1/8	1 3/8	1 3/8	1 3/8	1 5/8	3/4	7/8	7/8	7/8	1 1/8	5/8	3/4	3/4	3/4	7/8	7.50	92,000
120,000	10.00	1 3/8	1 3/8	1 5/8	1 5/8	1 5/8	7/8	7/8	1 1/8	1 1/8	1 3/8	3/4	3/4	7/8	7/8	1 1/8	10.00	120,000
150,000	12.50	1 3/8	1 5/8	1 5/8	1 5/8	2 1/8	7/8	1 1/8	1 1/8	1 3/8	1 3/8	3/4	7/8	7/8	1 1/8	1 1/8	12.50	150,000
180,000	15.00	1 3/8	1 5/8	1 5/8	2 1/8	2 1/8	7/8	1 1/8	1 3/8	1 3/8	1 3/8	3/4	7/8	1 1/8	1 1/8	1 1/8	15.00	180,000
240,000	20.00	1 5/8	2 1/8	2 1/8	2 1/8	2 1/8	1 1/8	1 3/8	1 3/8	1 3/8	1 3/8	7/8	1 1/8	1 1/8	1 1/8	1 1/8	20.00	240,000
300,000	25.00	1 5/8	2 1/8	2 1/8	2 1/8	2 5/8	1 1/8	1 3/8	1 3/8	1 5/8	1 5/8	7/8	1 1/8	1 1/8	1 3/8	1 3/8	25.00	300,000
360,000	30.00	2 1/8	2 1/8	2 1/8	2 5/8	2 5/8	1 3/8	1 3/8	1 3/8	1 5/8	1 5/8	1 1/8	1 1/8	1 1/8	1 3/8	1 3/8	30.00	360,000
420,000	35.00	2 1/8	2 1/8	2 5/8	2 5/8	2 5/8	1 3/8	1 3/8	1 5/8	1 5/8	2 1/8	1 1/8	1 1/8	1 3/8	1 3/8	1 5/8	35.00	420,000
480,000	40.00	2 1/8	2 5/8	2 5/8	2 5/8	2 5/8	1 3/8	1 5/8	1 5/8	1 5/8	2 1/8	1 1/8	1 3/8	1 3/8	1 3/8	1 5/8	40.00	480,000
540,000	45.00	2 1/8	2 5/8	2 5/8	2 5/8	3 1/8	1 3/8	1 5/8	1 5/8	2 1/8	2 1/8	1 1/8	1 3/8	1 3/8	1 5/8	1 5/8	45.00	540,000
600,000	50.00	2 1/8	2 5/8	2 5/8	3 1/8	3 1/8	1 3/8	1 5/8	1 5/8	2 1/8	2 1/8	1 1/8	1 3/8	1 3/8	1 5/8	1 5/8	50.00	600,000

- Refer to DuPont Refrigerant Expert, version 2.0 for actual velocities and pressure drops.
- Equivalent length is actual length plus friction losses caused by fittings and accessories.
- Line sizes are expressed in outside diameter of type “L” copper tubing.
- Line sizes are calculated at rated full load system capacity.
- All selections are based on a maximum of 65° F return gas entering the compressor and a refrigerant condensing and liquid line temperature of 105° F.

FREON "12" REFRIGERANT PRESSURE DROP IN LINES (65°F Evap. Outlet)

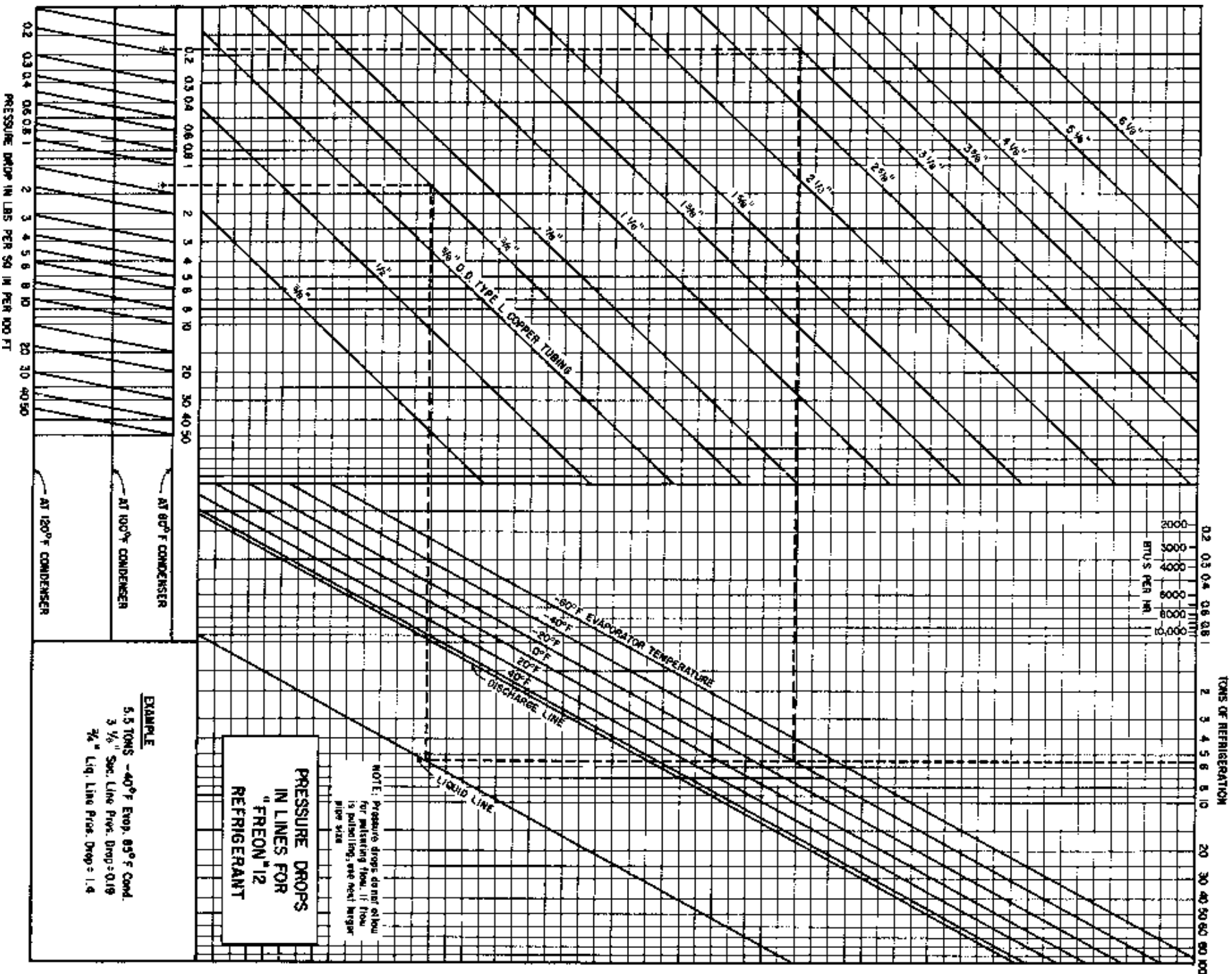

**PRESSURE DROPS
IN LINES FOR
FREON "12
REFRIGERANT**

NOTE: Pressure drops do not allow for piping that is not included in piping size.

EXAMPLE
5.5 TONS -40°F Evap, 85°F Cond.
3 1/2" Svc. Line Drop=0.19
3/4" Liq. Line Pres. Drop=1.4

FREON "12" REFRIGERANT VELOCITY IN LINES (65°F Evap. Outlet)

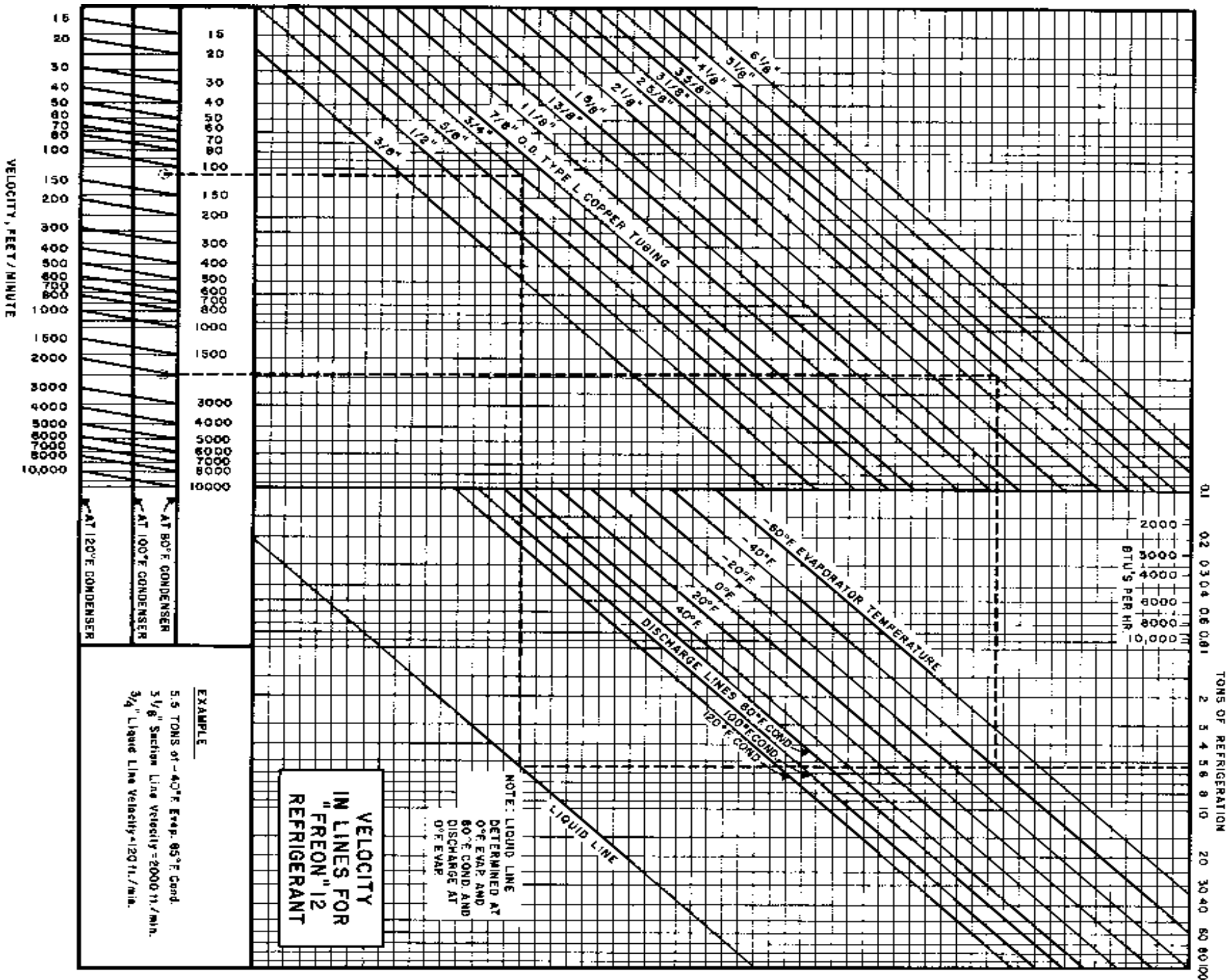



The miracles of science™

Suva[®]
refrigerants

Refrigerant

Freon 13 (R-13)

Piping Guide

From 12,000 BTU through 240,000 BTU per hour at -115° F through -30° F saturated suction temperature. (1.0 ton through 20.0 tons)

“Quick Pick”

Note:

This data is for the selection of the second stage refrigeration piping of a typical cascade refrigeration system ONLY. In the first stage use Suva 404A (R-404A) refrigerant and select the suggested pipe size from the Suva 404A (R-404A) refrigerant piping guide.



Freon 13 Refrigerant Piping Guide

Suction Line Size .. Evaporator to Compressor

		- 30° F through -59° F (92 through 45 psig)					- 60° F through - 100° F (44 through 7 psig)					- 101° F through - 115° F (7 psig through 1" Hg)						
		Suggested Allowable Pressure Drop in psig = 2F°																
		3.2 lbs. (2F°)					1.9 lbs. (2F°)					1.1 lbs. (2F°)						
System Capacity BTU/Hr.	System Capacity Tons/Hr	Equivalent Suction Line Lengths ... feet															System Capacity Tons/Hr	System Capacity BTU/Hr.
		25	50	75	100	150	25	50	75	100	150	25	50	75	100	150		
12,000	1.00	5/8	3/4	3/4	3/4		3/4	7/8	1 1/8	1 1/8		1 1/8	1 1/8	1 1/8	1 3/8		1.00	12,000
18,000	1.50	3/4	3/4	7/8	7/8		7/8	1 1/8	1 1/8	1 1/8		1 1/8	1 3/8	1 3/8	1 3/8		1.50	18,000
24,000	2.00	3/4	7/8	7/8	1 1/8	N/A	1 1/8	1 1/8	1 3/8	1 3/8	N/A	1 3/8	1 3/8	1 5/8	1 5/8		2.00	24,000
30,000	2.50	7/8	7/8	1 1/8	1 1/8		1 1/8	1 3/8	1 3/8	1 3/8		1 3/8	1 5/8	1 5/8	2 1/8	N/A	2.50	30,000
36,000	3.00	7/8	1 1/8	1 1/8	1 1/8		1 1/8	1 3/8	1 3/8	1 5/8		1 3/8	1 5/8	2 1/8	2 1/8		3.00	36,000
42,000	3.50	7/8	1 1/8	1 1/8	1 1/8		1 3/8	1 3/8	1 5/8	1 5/8		1 5/8	1 5/8	2 1/8	2 1/8		3.50	42,000
48,000	4.00	1 1/8	1 1/8	1 1/8	1 3/8		1 3/8	1 5/8	1 5/8	1 5/8		1 5/8	2 1/8	2 1/8	2 1/8		4.00	48,000
60,000	5.00	1 1/8	1 1/8	1 3/8	1 3/8		1 3/8	1 5/8	2 1/8	2 1/8		1 5/8	2 1/8	2 1/8	2 1/8		5.00	60,000
92,000	7.50	1 1/8	1 3/8	1 5/8	1 5/8	N/A	1 5/8	2 1/8	2 1/8	2 1/8	N/A	2 1/8	2 1/8	2 5/8	2 5/8		7.50	92,000
120,000	10.00	1 3/8	1 5/8	1 5/8	2 1/8		2 1/8	2 1/8	2 5/8	2 5/8		2 1/8	2 5/8	2 5/8	3 1/8	N/A	10.00	120,000
180,000	15.00	1 5/8	2 1/8	2 1/8	2 1/8		2 1/8	2 5/8	2 5/8	2 5/8		2 5/8	3 1/8	3 1/8	3 5/8		15.00	180,000
240,000	20.00	1 5/8	2 1/8	2 1/8	2 1/8		2 5/8	2 5/8	3 1/8	3 1/8		3 1/8	3 1/8	3 5/8	3 5/8		20.00	240,000
300,000	25.00																25.00	300,000
360,000	30.00																30.00	360,000
420,000	35.00	N/A	N/A	N/A	N/A	N/A	N/A	N/A	N/A	N/A	N/A	N/A	N/A	N/A	N/A	N/A	35.00	420,000
480,000	40.00																40.00	480,000
540,000	45.00																45.00	540,000
600,000	50.00																50.00	600,000

- Refer to DuPont Refrigerant Expert, version 2.0 for actual velocities and pressure drops.
- Equivalent length is actual length plus friction losses caused by fittings and accessories.
- Line sizes are expressed in outside diameter of type “L” copper tubing.
- Line sizes are calculated at rated full load system capacity.
- All selections are based on a maximum of - 20° F return gas entering the compressor and a refrigerant condensing and liquid line temperature of + 20° F.



Freon 13 Refrigerant Piping Guide



		Discharge Line Size Compressor to Condenser <small>1F° (6.5 psi) pressure drop maximum</small>					Liquid Condensate Line Condenser to Receiver <small>Condensate drain / vent</small>					Liquid Line Size Receiver to TXV <small>1F° (4.6 psi) pressure drop maximum</small>						
System Capacity BTU/Hr.	System Capacity Tons/Hr	Equivalent Line Lengths ... feet															System Capacity Tons/Hr	System Capacity BTU/Hr.
		25	50	75	100	150	25	50	75	100	150	25	50	75	100	150		
12,000	1.00	1/2	1/2	5/8	5/8		1/2	1/2	1/2	1/2		3/8	3/8	3/8	3/8		1.00	12,000
18,000	1.50	1/2	5/8	5/8	5/8		1/2	5/8	5/8	5/8		3/8	1/2	1/2	1/2		1.50	18,000
24,000	2.00	5/8	5/8	3/4	3/4	N/A	1/2	5/8	5/8	5/8	N/A	3/8	1/2	1/2	1/2	N/A	2.00	24,000
30,000	2.50	5/8	3/4	3/4	3/4		5/8	5/8	5/8	3/4		1/2	1/2	1/2	5/8		2.50	30,000
36,000	3.00	5/8	3/4	3/4	7/8		5/8	5/8	3/4	3/4		1/2	1/2	5/8	5/8		3.00	36,000
42,000	3.50	3/4	3/4	7/8	7/8		5/8	3/4	3/4	3/4		1/2	5/8	5/8	5/8		3.50	42,000
48,000	4.00	3/4	7/8	7/8	7/8		5/8	3/4	3/4	3/4		1/2	5/8	5/8	5/8		4.00	48,000
60,000	5.00	3/4	7/8	1 1/8	1 1/8		5/8	3/4	3/4	7/8		1/2	5/8	5/8	3/4		5.00	60,000
92,000	7.50	7/8	1 1/8	1 1/8	1 1/8	N/A	3/4	7/8	7/8	7/8	N/A	5/8	3/4	3/4	3/4	N/A	7.50	92,000
120,000	10.00	1 1/8	1 1/8	1 3/8	1 3/8		7/8	7/8	1 1/8	1 1/8		3/4	3/4	7/8	7/8		10.00	120,000
180,000	15.00	1 1/8	1 3/8	1 3/8	1 5/8		7/8	1 1/8	1 3/8	1 3/8		3/4	7/8	1 1/8	1 1/8		15.00	180,000
240,000	20.00	1 3/8	1 3/8	1 5/8	1 5/8		1 1/8	1 3/8	1 3/8	1 3/8		7/8	1 1/8	1 1/8	1 1/8		20.00	240,000
300,000	25.00	N/A	N/A	N/A	N/A	N/A	N/A	N/A	N/A	N/A	N/A	N/A	N/A	N/A	N/A	N/A	25.00	300,000
360,000	30.00	N/A	N/A	N/A	N/A	N/A	N/A	N/A	N/A	N/A	N/A	N/A	N/A	N/A	N/A	N/A	30.00	360,000
420,000	35.00	N/A	N/A	N/A	N/A	N/A	N/A	N/A	N/A	N/A	N/A	N/A	N/A	N/A	N/A	N/A	35.00	420,000
480,000	40.00	N/A	N/A	N/A	N/A	N/A	N/A	N/A	N/A	N/A	N/A	N/A	N/A	N/A	N/A	N/A	40.00	480,000
540,000	45.00	N/A	N/A	N/A	N/A	N/A	N/A	N/A	N/A	N/A	N/A	N/A	N/A	N/A	N/A	N/A	45.00	540,000
600,000	50.00	N/A	N/A	N/A	N/A	N/A	N/A	N/A	N/A	N/A	N/A	N/A	N/A	N/A	N/A	N/A	50.00	600,000

- Refer to DuPont Refrigerant Expert, version 2.0 for actual velocities and pressure drops.
- Equivalent length is actual length plus friction losses caused by fittings and accessories.
- Line sizes are expressed in outside diameter of type “L” copper tubing.
- Line sizes are calculated at rated full load system capacity.
- All selections are based on a maximum of - 20° F return gas entering the compressor and a refrigerant condensing and liquid line temperature of + 20° F.



The miracles of science™

Suva[®]
refrigerants

Refrigerant

Freon 114 (R-114)

Piping Guide

From 12,000 BTU through 240,000 BTU per hour at -10° F through + 50° F saturated suction temperature. (1.0 ton through 20.0 tons)

“Quick Pick”



Freon 114 Refrigerant Piping Guide

Suction Line Size .. Evaporator to Compressor

		50° F through 30° F (4 psig through 6" Hg)					29° F through 10° F (6" through 14" Hg)					9° F through -10° F (15" through 20" Hg)						
		Suggested Allowable Pressure Drop in psig = 2F°																
		0.7 lbs. (2F°)					0.4 lbs. (2F°)					0.3 lbs. (2F°)						
System Capacity BTU/Hr.	System Capacity Tons/Hr	Equivalent Suction Line Lengths ... feet															System Capacity Tons/Hr	System Capacity BTU/Hr.
		25	50	75	100	150	25	50	75	100	150	25	50	75	100	150		
12,000	1.00	1 1/8	1 1/8	1 1/8	1 3/8		1 1/8	1 3/8	1 5/8	1 5/8		1 3/8	1 5/8	1 5/8	2 1/8		1.00	12,000
18,000	1.50	1 1/8	1 3/8	1 3/8	1 3/8		1 3/8	1 5/8	1 5/8	2 1/8		1 5/8	2 1/8	2 1/8	2 1/8		1.50	18,000
24,000	2.00	1 3/8	1 3/8	1 5/8	1 5/8	N/A	1 5/8	2 1/8	2 1/8	2 1/8	N/A	2 1/8	2 1/8	2 1/8	2 5/8		2.00	24,000
30,000	2.50	1 3/8	1 5/8	1 5/8	1 5/8		1 5/8	2 1/8	2 1/8	2 1/8		2 1/8	2 1/8	2 5/8	2 5/8	N/A	2.50	30,000
36,000	3.00	1 3/8	1 5/8	2 1/8	2 1/8		2 1/8	2 1/8	2 1/8	2 5/8		2 1/8	2 5/8	2 5/8	3 1/8		3.00	36,000
42,000	3.50	1 5/8	2 1/8	2 1/8	2 1/8		2 1/8	2 1/8	2 5/8	2 5/8		2 1/8	2 5/8	2 5/8	3 1/8		3.50	42,000
48,000	4.00	1 5/8	2 1/8	2 1/8	2 1/8		2 1/8	2 5/8	2 5/8	2 5/8		2 5/8	2 5/8	3 1/8	3 1/8		4.00	48,000
60,000	5.00	1 5/8	2 1/8	2 1/8	2 1/8		2 1/8	2 5/8	2 5/8	2 5/8		2 5/8	3 1/8	3 1/8	3 1/8		5.00	60,000
92,000	7.50	2 1/8	2 5/8	2 5/8	2 5/8	N/A	2 5/8	3 1/8	3 1/8	3 1/8	N/A	3 1/8	3 5/8	3 5/8	3 5/8		7.50	92,000
120,000	10.00	2 5/8	2 5/8	2 5/8	3 1/8		2 5/8	3 1/8	3 5/8	3 5/8		3 5/8	3 5/8	4 1/8	4 1/8		10.00	120,000
180,000	15.00	2 5/8	3 1/8	3 1/8	3 5/8		3 1/8	3 5/8	4 1/8	4 1/8		3 5/8	4 1/8	5 1/8	5 1/8		15.00	180,000
240,000	20.00	3 1/8	3 5/8	3 5/8	3 5/8		3 5/8	4 1/8	5 1/8	5 1/8		4 1/8	5 1/8	5 1/8	6 1/8		20.00	240,000
300,000	25.00																25.00	300,000
360,000	30.00																30.00	360,000
420,000	35.00	N/A	N/A	N/A	N/A	N/A	N/A	N/A	N/A	N/A	N/A	N/A	N/A	N/A	N/A	N/A	35.00	420,000
480,000	40.00																40.00	480,000
540,000	45.00																45.00	540,000
600,000	50.00																50.00	600,000

- Refer to DuPont Refrigerant Expert, version 2.0 for actual velocities and pressure drops.
- Equivalent length is actual length plus friction losses caused by fittings and accessories.
- Line sizes are expressed in outside diameter of type "L" copper tubing.
- Line sizes are calculated at rated full load system capacity.
- All selections are based on a maximum of 65° F return gas entering the compressor and a refrigerant condensing and liquid line temperature of 105° F.



Freon 114 Refrigerant Piping Guide



		Discharge Line Size Compressor to Condenser <small>1F° (0.8 psi) pressure drop maximum</small>					Liquid Condensate Line Condenser to Receiver <small>Condensate drain / vent</small>					Liquid Line Size Receiver to TXV <small>1F° (0.8 psi) pressure drop maximum</small>						
System Capacity BTU/Hr.	System Capacity Tons/Hr	Equivalent Line Lengths ... feet															System Capacity Tons/Hr	System Capacity BTU/Hr.
		25	50	75	100	150	25	50	75	100	150	25	50	75	100	150		
12,000	1.00	3/4	7/8	7/8	1 1/8		1/2	5/8	5/8	5/8		3/8	1/2	1/2	1/2		1.00	12,000
18,000	1.50	7/8	1 1/8	1 1/8	1 1/8		5/8	5/8	5/8	3/4		1/2	1/2	1/2	5/8		1.50	18,000
24,000	2.00	1 1/8	1 1/8	1 1/8	1 3/8	N/A	5/8	3/4	3/4	3/4	N/A	1/2	5/8	5/8	5/8		2.00	24,000
30,000	2.50	1 1/8	1 1/8	1 3/8	1 3/8		5/8	3/4	3/4	7/8		1/2	5/8	5/8	3/4	N/A	2.50	30,000
36,000	3.00	1 1/8	1 3/8	1 3/8	1 3/8		3/4	3/4	7/8	7/8		5/8	5/8	3/4	3/4		3.00	36,000
42,000	3.50	1 1/8	1 3/8	1 3/8	1 5/8		3/4	7/8	7/8	7/8		5/8	3/4	3/4	3/4		3.50	42,000
48,000	4.00	7/8	1 3/8	1 5/8	1 5/8		3/4	7/8	7/8	7/8		5/8	3/4	3/4	3/4		4.00	48,000
60,000	5.00	7/8	1 5/8	1 5/8	1 5/8		3/4	7/8	1 1/8	1 1/8		5/8	3/4	7/8	7/8		5.00	60,000
92,000	7.50	1 1/8	2 1/8	2 1/8	2 1/8	N/A	7/8	1 1/8	1 1/8	1 3/8	N/A	3/4	7/8	7/8	1 1/8	N/A	7.50	92,000
120,000	10.00	1 1/8	2 1/8	2 1/8	2 1/8		1 1/8	1 3/8	1 3/8	1 3/8		7/8	1 1/8	1 1/8	1 1/8		10.00	120,000
180,000	15.00	1 3/8	2 5/8	2 5/8	2 5/8		1 3/8	1 3/8	1 3/8	1 5/8		1 1/8	1 1/8	1 1/8	1 3/8		15.00	180,000
240,000	20.00	1 3/8	2 5/8	2 5/8	3 1/8		1 3/8	1 5/8	1 5/8	1 5/8		1 1/8	1 3/8	1 3/8	1 3/8		20.00	240,000
300,000	25.00																25.00	300,000
360,000	30.00																30.00	360,000
420,000	35.00	N/A	N/A	N/A	N/A	N/A	N/A	N/A	N/A	N/A	N/A	N/A	N/A	N/A	N/A	N/A	35.00	420,000
480,000	40.00																40.00	480,000
540,000	45.00																45.00	540,000
600,000	50.00																50.00	600,000

- Refer to DuPont Refrigerant Expert, version 2.0 for actual velocities and pressure drops.
- Equivalent length is actual length plus friction losses caused by fittings and accessories.
- Line sizes are expressed in outside diameter of type “L” copper tubing.
- Line sizes are calculated at rated full load system capacity.
- All selections are based on a maximum of 65° F return gas entering the compressor and a refrigerant condensing and liquid line temperature of 105° F.



The miracles of science™

Suva[®]
refrigerants

Refrigerant

Freon 500 (R-500)

Piping Guide

From 18,000 BTU through 600,000 BTU per hour at -30° F through + 50° F saturated suction temperature. (1.5 ton through 50.0 tons)

“Quick Pick”



Freon 500 Refrigerant Piping Guide



Suction Line Size .. Evaporator to Compressor

		50° F through 30° F (58 through 36 psig)					29° F through 10° F (35 through 20 psig)					9° F through -10° F (19 through 8 psig)						
		Suggested Allowable Pressure Drop in psig = 2F°																
		2.2 lbs. (2F°)					1.6 lbs. (2F°)					1.2 lbs. (2F°)						
System Capacity BTU/Hr.	System Capacity Tons/Hr	Equivalent Suction Line Lengths ... feet															System Capacity Tons/Hr	System Capacity BTU/Hr.
		25	50	75	100	150	25	50	75	100	150	25	50	75	100	150		
18,000	1.50	5/8	3/4	7/8	7/8	7/8	3/4	7/8	1 1/8	1 1/8	1 1/8	7/8	1 1/8	1 1/8	1 1/8	1 3/8	1.50	18,000
24,000	2.00	3/4	7/8	7/8	1 1/8	1 1/8	7/8	1 1/8	1 1/8	1 1/8	1 1/8	1 1/8	1 1/8	1 3/8	1 3/8	1 3/8	2.00	24,000
30,000	2.50	7/8	7/8	1 1/8	1 1/8	1 1/8	7/8	1 1/8	1 1/8	1 3/8	1 3/8	1 1/8	1 3/8	1 3/8	1 3/8	1 5/8	2.50	30,000
36,000	3.00	7/8	1 1/8	1 1/8	1 1/8	1 1/8	1 1/8	1 1/8	1 3/8	1 3/8	1 3/8	1 1/8	1 3/8	1 3/8	1 5/8	1 5/8	3.00	36,000
42,000	3.50	7/8	1 1/8	1 1/8	1 1/8	1 3/8	1 1/8	1 1/8	1 3/8	1 3/8	1 5/8	1 1/8	1 3/8	1 5/8	1 5/8	1 5/8	3.50	42,000
48,000	4.00	7/8	1 1/8	1 1/8	1 1/8	1 3/8	1 1/8	1 3/8	1 3/8	1 3/8	1 5/8	1 3/8	1 3/8	1 5/8	1 5/8	2 1/8	4.00	48,000
60,000	5.00	1 1/8	1 1/8	1 3/8	1 3/8	1 3/8	1 1/8	1 3/8	1 3/8	1 5/8	1 5/8	1 3/8	1 5/8	1 5/8	2 1/8	2 1/8	5.00	60,000
92,000	7.50	1 1/8	1 3/8	1 3/8	1 5/8	1 5/8	1 3/8	1 5/8	1 5/8	2 1/8	2 1/8	1 5/8	2 1/8	2 1/8	2 1/8	2 1/8	7.50	92,000
120,000	10.00	1 3/8	1 5/8	1 5/8	1 5/8	2 1/8	1 5/8	2 1/8	2 1/8	2 1/8	2 1/8	2 1/8	2 1/8	2 1/8	2 5/8	2 5/8	10.00	120,000
150,000	12.50	1 3/8	1 5/8	2 1/8	2 1/8	2 1/8	1 5/8	2 1/8	2 1/8	2 1/8	2 5/8	2 1/8	2 1/8	2 5/8	2 5/8	2 5/8	12.50	150,000
180,000	15.00	1 5/8	1 5/8	2 1/8	2 1/8	2 1/8	2 1/8	2 1/8	2 1/8	2 5/8	2 5/8	2 1/8	2 5/8	2 5/8	2 5/8	3 1/8	15.00	180,000
240,000	20.00	1 5/8	2 1/8	2 1/8	2 1/8	2 5/8	2 1/8	2 1/8	2 1/8	2 5/8	3 1/8	2 1/8	2 5/8	3 1/8	3 1/8	3 1/8	20.00	240,000
300,000	25.00	2 1/8	2 1/8	2 1/8	2 5/8	2 5/8	2 1/8	2 5/8	2 5/8	2 5/8	3 1/8	2 5/8	2 5/8	3 1/8	3 1/8	3 5/8	25.00	300,000
360,000	30.00	2 1/8	2 1/8	2 5/8	2 5/8	2 5/8	2 1/8	2 5/8	2 5/8	3 1/8	3 1/8	2 5/8	3 1/8	3 1/8	3 5/8	3 5/8	30.00	360,000
420,000	35.00	2 1/8	2 5/8	2 5/8	2 5/8	3 1/8	2 5/8	2 5/8	3 1/8	3 1/8	3 5/8	3 1/8	3 1/8	3 5/8	3 5/8	4 1/8	35.00	420,000
480,000	40.00	2 1/8	2 5/8	2 5/8	3 1/8	3 1/8	2 5/8	3 1/8	3 1/8	3 5/8	3 5/8	3 1/8	3 5/8	3 5/8	3 5/8	4 1/8	40.00	480,000
540,000	45.00	2 1/8	2 5/8	3 1/8	3 1/8	3 1/8	2 5/8	3 1/8	3 1/8	3 5/8	3 5/8	3 1/8	3 5/8	3 5/8	4 1/8	4 1/8	45.00	540,000
600,000	50.00	2 5/8	2 5/8	3 1/8	3 1/8	3 5/8	2 5/8	3 1/8	3 5/8	3 5/8	4 1/8	3 1/8	3 5/8	4 1/8	4 1/8	5 1/8	50.00	600,000

- Refer to DuPont Refrigerant Expert, version 2.0 for actual velocities and pressure drops.
- Equivalent length is actual length plus friction losses caused by fittings and accessories.
- Line sizes are expressed in outside diameter of type “L” copper tubing.
- Line sizes are calculated at rated full load system capacity.
- All selections are based on a maximum of 65° F return gas entering the compressor and a refrigerant condensing and liquid line temperature of 105° F.



Freon 500 Refrigerant Piping Guide



Suction Line Size .. Evaporator to Compressor

		- 11° F through - 30° F (7 psig through 2" Hg)					- 31° F through - 50° F (2 " through 13" Hg)						
		Suggested Allowable Pressure Drop in psig = 2F°											
		0.8 lbs. (2F°)					0.6 lbs. (2F°)						
System Capacity BTU/Hr.	System Capacity Tons/Hr	Equivalent Suction Lengths ... feet										System Capacity Tons/Hr	System Capacity BTU/Hr.
		25	50	75	100	150	25	50	75	100	150		
18,000	1.50	1 1/8	1 3/8	1 3/8	1 3/8	1 5/8						1.50	18,000
24,000	2.00	1 1/8	1 3/8	1 3/8	1 5/8	1 5/8						2.00	24,000
30,000	2.50	1 3/8	1 3/8	1 5/8	1 5/8	2 1/8	N/A	N/A	N/A	N/A	N/A	2.50	30,000
36,000	3.00	1 3/8	1 5/8	1 5/8	2 1/8	2 1/8						3.00	36,000
42,000	3.50	1 3/8	1 5/8	2 1/8	2 1/8	2 1/8						3.50	42,000
48,000	4.00	1 5/8	1 5/8	2 1/8	2 1/8	2 1/8						4.00	48,000
60,000	5.00	1 5/8	2 1/8	2 1/8	2 5/8	2 5/8						5.00	60,000
92,000	7.50	2 1/8	2 1/8	2 5/8	2 5/8	2 5/8						7.50	92,000
120,000	10.00	2 1/8	2 5/8	2 5/8	3 1/8	3 1/8	N/A	N/A	N/A	N/A	N/A	10.00	120,000
150,000	12.50	2 5/8	2 5/8	2 5/8	3 1/8	3 1/8						12.50	150,000
180,000	15.00	2 5/8	2 5/8	3 1/8	3 5/8	3 5/8						15.00	180,000
240,000	20.00	2 5/8	3 1/8	3 5/8	3 5/8	3 5/8						20.00	240,000
300,000	25.00	3 1/8	3 5/8	3 5/8	3 5/8	4 1/8						25.00	300,000
360,000	30.00	3 1/8	3 5/8	3 5/8	4 1/8	5 1/8						30.00	360,000
420,000	35.00	3 5/8	3 5/8	4 1/8	4 1/8	5 1/8	N/A	N/A	N/A	N/A	N/A	35.00	420,000
480,000	40.00	3 5/8	4 1/8	4 1/8	5 1/8	5 1/8						40.00	480,000
540,000	45.00	3 5/8	4 1/8	5 1/8	5 1/8	5 1/8						45.00	540,000
600,000	50.00	3 5/8	5 1/8	5 1/8	5 1/8	5 1/8						50.00	600,000

- Refer to DuPont Refrigerant Expert, version 2.0 for actual velocities and pressure drops.
- Equivalent length is actual length plus friction losses caused by fittings and accessories.
- Line sizes are expressed in outside diameter of type "L" copper tubing.
- Line sizes are calculated at rated full load system capacity.
- All selections are based on a maximum of 65° F return gas entering the compressor and a refrigerant condensing and liquid line temperature of 105° F.



Freon 500 Refrigerant Piping Guide



		Discharge Line Size Compressor to Condenser <small>1F° (2.3 psi) pressure drop maximum</small>					Liquid Condensate Line Condenser to Receiver <small>Condensate drain / vent</small>					Liquid Line Size Receiver to TXV <small>1F° (2.3 psi) pressure drop maximum</small>						
System Capacity BTU/Hr.	System Capacity Tons/Hr	Equivalent Line Lengths ... feet															System Capacity Tons/Hr	System Capacity BTU/Hr.
		25	50	75	100	150	25	50	75	100	150	25	50	75	100	150		
18,000	1.50	5/8	5/8	3/4	3/4	7/8	1/2	1/2	1/2	5/8	5/8	3/8	3/8	3/8	1/2	1/2	1.50	18,000
24,000	2.00	5/8	3/4	3/4	3/4	7/8	1/2	5/8	5/8	5/8	5/8	3/8	1/2	1/2	1/2	1/2	2.00	24,000
30,000	2.50	3/4	3/4	7/8	7/8	7/8	1/2	5/8	5/8	5/8	3/4	3/8	1/2	1/2	1/2	5/8	2.50	30,000
36,000	3.00	3/4	7/8	7/8	7/8	1 1/8	5/8	5/8	5/8	3/4	3/4	1/2	1/2	1/2	5/8	5/8	3.00	36,000
42,000	3.50	3/4	7/8	7/8	1 1/8	1 1/8	5/8	5/8	3/4	3/4	3/4	1/2	1/2	5/8	5/8	5/8	3.50	42,000
48,000	4.00	3/4	7/8	1 1/8	1 1/8	1 1/8	5/8	5/8	3/4	3/4	3/4	1/2	1/2	5/8	5/8	5/8	4.00	48,000
60,000	5.00	7/8	1 1/8	1 1/8	1 1/8	1 1/8	5/8	3/4	3/4	3/4	7/8	1/2	5/8	5/8	5/8	3/4	5.00	60,000
92,000	7.50	1 1/8	1 1/8	1 3/8	1 3/8	1 3/8	3/4	3/4	7/8	7/8	7/8	5/8	5/8	3/4	3/4	3/4	7.50	92,000
120,000	10.00	1 1/8	1 3/8	1 3/8	1 3/8	1 5/8	3/4	7/8	7/8	1 1/8	1 1/8	5/8	3/4	3/4	7/8	7/8	10.00	120,000
150,000	12.50	1 1/8	1 3/8	1 3/8	1 5/8	1 5/8	7/8	7/8	1 1/8	1 1/8	1 3/8	3/4	3/4	7/8	7/8	1 1/8	12.50	150,000
180,000	15.00	1 3/8	1 3/8	1 5/8	1 5/8	2 1/8	7/8	1 1/8	1 1/8	1 3/8	1 3/8	3/4	7/8	7/8	1 1/8	1 1/8	15.00	180,000
240,000	20.00	1 3/8	1 5/8	2 1/8	2 1/8	2 1/8	7/8	1 1/8	1 3/8	1 3/8	1 3/8	3/4	7/8	1 1/8	1 1/8	1 1/8	20.00	240,000
300,000	25.00	1 5/8	2 1/8	2 1/8	2 1/8	2 1/8	1 1/8	1 3/8	1 3/8	1 3/8	1 5/8	7/8	1 1/8	1 1/8	1 1/8	1 3/8	25.00	300,000
360,000	30.00	1 5/8	2 1/8	2 1/8	2 1/8	2 5/8	1 1/8	1 3/8	1 3/8	1 3/8	1 5/8	7/8	1 1/8	1 1/8	1 1/8	1 3/8	30.00	360,000
420,000	35.00	1 5/8	2 1/8	2 1/8	2 1/8	2 5/8	1 3/8	1 3/8	1 5/8	1 5/8	1 5/8	1 1/8	1 1/8	1 3/8	1 3/8	1 3/8	35.00	420,000
480,000	40.00	2 1/8	2 1/8	2 1/8	2 5/8	2 5/8	1 3/8	1 3/8	1 5/8	1 5/8	1 5/8	1 1/8	1 1/8	1 3/8	1 3/8	1 3/8	40.00	480,000
540,000	45.00	2 1/8	2 1/8	2 5/8	2 5/8	2 5/8	1 3/8	1 5/8	1 5/8	1 5/8	2 1/8	1 1/8	1 3/8	1 3/8	1 3/8	1 5/8	45.00	540,000
600,000	50.00	2 1/8	2 1/8	2 5/8	2 5/8	2 5/8	1 3/8	1 5/8	1 5/8	1 5/8	2 1/8	1 1/8	1 3/8	1 3/8	1 3/8	1 5/8	50.00	600,000

- Refer to DuPont Refrigerant Expert, version 2.0 for actual velocities and pressure drops.
- Equivalent length is actual length plus friction losses caused by fittings and accessories.
- Line sizes are expressed in outside diameter of type “L” copper tubing.
- Line sizes are calculated at rated full load system capacity.
- All selections are based on a maximum of 65° F return gas entering the compressor and a refrigerant condensing and liquid line temperature of 105° F.



The miracles of science™

Suva®
refrigerants

Refrigerant

Freon 502 (R-502)

Piping Guide

From 18,000 BTU through 600,000 BTU per hour at -50° F through + 50° F saturated suction temperature. (1.5 ton through 50.0 tons)

“Quick Pick”



Freon 502 Refrigerant Piping Guide

Suction Line Size .. Evaporator to Compressor

		50° F through 30° F (98 through 66 psig)					29° F through 10° F (64 through 41 psig)					9° F through -10° F (41 through 22 psig)						
		Suggested Allowable Pressure Drop in psig = 2F°																
		3.2 lbs. (2F°)					2.4 lbs. (2F°)					2.0 lbs. (2F°)						
System Capacity BTU/Hr.	System Capacity Tons/Hr	Equivalent Suction Line Lengths ... feet															System Capacity Tons/Hr	System Capacity BTU/Hr.
		25	50	75	100	150	25	50	75	100	150	25	50	75	100	150		
18,000	1.50	5/8	3/4	3/4	7/8	7/8	3/4	7/8	7/8	7/8	1 1/8	7/8	7/8	1 1/8	1 1/8	1 1/8	1.50	18,000
24,000	2.00	3/4	3/4	7/8	7/8	1 1/8	3/4	7/8	1 1/8	1 1/8	1 1/8	7/8	1 1/8	1 1/8	1 1/8	1 3/8	2.00	24,000
30,000	2.50	3/4	7/8	7/8	1 1/8	1 1/8	7/8	1 1/8	1 1/8	1 1/8	1 1/8	1 1/8	1 1/8	1 1/8	1 3/8	1 3/8	2.50	30,000
36,000	3.00	3/4	7/8	1 1/8	1 1/8	1 1/8	7/8	1 1/8	1 1/8	1 1/8	1 3/8	1 1/8	1 1/8	1 3/8	1 3/8	1 3/8	3.00	36,000
42,000	3.50	7/8	1 1/8	1 1/8	1 1/8	1 1/8	1 1/8	1 1/8	1 1/8	1 3/8	1 3/8	1 1/8	1 3/8	1 3/8	1 3/8	1 5/8	3.50	42,000
48,000	4.00	7/8	1 1/8	1 1/8	1 1/8	1 3/8	1 1/8	1 1/8	1 3/8	1 3/8	1 3/8	1 1/8	1 3/8	1 3/8	1 5/8	1 5/8	4.00	48,000
60,000	5.00	1 1/8	1 1/8	1 1/8	1 3/8	1 3/8	1 1/8	1 3/8	1 5/8	1 3/8	1 5/8	1 3/8	1 3/8	1 5/8	1 5/8	2 1/8	5.00	60,000
92,000	7.50	1 1/8	1 3/8	1 3/8	1 3/8	1 5/8	1 3/8	1 3/8	1 5/8	1 5/8	2 1/8	1 3/8	1 5/8	2 1/8	2 1/8	2 1/8	7.50	92,000
120,000	10.00	1 3/8	1 3/8	1 5/8	1 5/8	1 5/8	1 3/8	1 5/8	1 5/8	2 1/8	2 1/8	1 5/8	2 1/8	2 1/8	2 1/8	2 1/8	10.00	120,000
150,000	12.50	1 3/8	1 5/8	1 5/8	1 5/8	2 1/8	1 5/8	2 1/8	2 1/8	2 1/8	2 1/8	1 5/8	2 1/8	2 1/8	2 1/8	2 5/8	12.50	150,000
180,000	15.00	1 3/8	1 5/8	1 5/8	2 1/8	2 1/8	1 5/8	2 1/8	2 1/8	2 1/8	2 5/8	2 1/8	2 1/8	2 5/8	2 5/8	2 5/8	15.00	180,000
240,000	20.00	1 5/8	2 1/8	2 1/8	2 1/8	2 1/8	2 1/8	2 1/8	2 1/8	2 5/8	2 5/8	2 1/8	2 5/8	2 5/8	2 5/8	3 1/8	20.00	240,000
300,000	25.00	1 5/8	2 1/8	2 1/8	2 1/8	2 5/8	2 1/8	2 1/8	2 5/8	2 5/8	2 5/8	2 1/8	2 5/8	2 5/8	3 1/8	3 1/8	25.00	300,000
360,000	30.00	2 1/8	2 1/8	2 1/8	2 5/8	2 5/8	2 1/8	2 5/8	2 5/8	2 5/8	3 1/8	2 5/8	2 5/8	3 1/8	3 1/8	3 5/8	30.00	360,000
420,000	35.00	2 1/8	2 1/8	2 5/8	2 5/8	2 5/8	2 1/8	2 5/8	2 5/8	3 1/8	3 1/8	2 5/8	3 1/8	3 1/8	3 5/8	3 5/8	35.00	420,000
480,000	40.00	2 1/8	2 5/8	2 5/8	2 5/8	3 1/8	2 5/8	2 5/8	3 1/8	3 1/8	3 5/8	2 5/8	3 1/8	3 1/8	3 5/8	3 5/8	40.00	480,000
540,000	45.00	2 1/8	2 5/8	2 5/8	2 5/8	3 1/8	2 5/8	3 1/8	3 1/8	3 1/8	3 5/8	2 5/8	3 1/8	3 5/8	3 5/8	4 1/8	45.00	540,000
600,000	50.00	2 1/8	2 5/8	2 5/8	3 1/8	3 1/8	2 5/8	3 1/8	3 1/8	3 1/8	3 5/8	3 1/8	3 5/8	3 5/8	3 5/8	4 1/8	50.00	600,000

- Refer to DuPont Refrigerant Expert, version 2.0 for actual velocities and pressure drops.
- Equivalent length is actual length plus friction losses caused by fittings and accessories.
- Line sizes are expressed in outside diameter of type “L” copper tubing.
- Line sizes are calculated at rated full load system capacity.
- All selections are based on a maximum of 65° F return gas entering the compressor and a refrigerant condensing and liquid line temperature of 105° F.



Freon 502 Refrigerant Piping Guide

Suction Line Size .. Evaporator to Compressor

		- 11° F through - 30° F (22 through 9 psig)					- 31° F through - 50° F (9 through 0 psig)						
		Suggested Allowable Pressure Drop in psig = 2F°											
		1.4 lbs. (2F°)					0.9 lbs. (2F°)						
System Capacity BTU/Hr.	System Capacity Tons/Hr	Equivalent Suction Lengths ... feet										System Capacity Tons/Hr	System Capacity BTU/Hr.
		25	50	75	100	150	25	50	75	100	150		
18,000	1.50	1 1/8	1 1/8	1 1/8	1 3/8	1 3/8	1 1/8	1 3/8	1 3/8	1 5/8	1 5/8	1.50	18,000
24,000	2.00	1 1/8	1 3/8	1 3/8	1 3/8	1 5/8	1 3/8	1 5/8	1 5/8	1 5/8	2 1/8	2.00	24,000
30,000	2.50	1 1/8	1 3/8	1 3/8	1 3/8	1 5/8	1 3/8	1 5/8	1 5/8	2 1/8	2 1/8	2.50	30,000
36,000	3.00	1 3/8	1 3/8	1 5/8	1 5/8	2 1/8	1 5/8	1 5/8	2 1/8	2 1/8	2 1/8	3.00	36,000
42,000	3.50	1 3/8	1 5/8	1 5/8	1 5/8	2 1/8	1 5/8	2 1/8	2 1/8	2 1/8	2 1/8	3.50	42,000
48,000	4.00	1 3/8	1 5/8	1 5/8	2 1/8	2 1/8	1 5/8	2 1/8	2 1/8	2 1/8	2 5/8	4.00	48,000
60,000	5.00	1 5/8	1 5/8	2 1/8	2 1/8	2 1/8	2 1/8	2 1/8	2 1/8	2 5/8	2 5/8	5.00	60,000
92,000	7.50	1 5/8	2 1/8	2 1/8	2 1/8	2 5/8	2 1/8	2 5/8	2 5/8	2 5/8	3 1/8	7.50	92,000
120,000	10.00	2 1/8	2 1/8	2 5/8	2 5/8	2 5/8	2 5/8	2 5/8	3 1/8	3 1/8	3 1/8	10.00	120,000
150,000	12.50	2 1/8	2 5/8	2 5/8	2 5/8	3 1/8	2 5/8	3 1/8	3 1/8	3 1/8	3 5/8	12.50	150,000
180,000	15.00	2 1/8	2 5/8	2 5/8	3 1/8	3 1/8	2 5/8	3 1/8	3 5/8	3 5/8	3 5/8	15.00	180,000
240,000	20.00	2 5/8	3 1/8	3 1/8	3 1/8	3 5/8	3 1/8	3 5/8	3 5/8	4 1/8	4 1/8	20.00	240,000
300,000	25.00	2 5/8	3 1/8	3 5/8	3 5/8	3 5/8	3 1/8	3 5/8	4 1/8	4 1/8	5 1/8	25.00	300,000
360,000	30.00	3 1/8	3 1/8	3 5/8	3 5/8	4 1/8	3 5/8	4 1/8	4 1/8	5 1/8	5 1/8	30.00	360,000
420,000	35.00	3 1/8	3 5/8	3 5/8	4 1/8	4 1/8	3 5/8	4 1/8	5 1/8	5 1/8	5 1/8	35.00	420,000
480,000	40.00	3 1/8	3 5/8	4 1/8	4 1/8	5 1/8	4 1/8	5 1/8	5 1/8	5 1/8	6 1/8	40.00	480,000
540,000	45.00	3 5/8	3 5/8	4 1/8	4 1/8	5 1/8	4 1/8	5 1/8	5 1/8	5 1/8	6 1/8	45.00	540,000
600,000	50.00	3 5/8	4 1/8	4 1/8	5 1/8	5 1/8	4 1/8	5 1/8	5 1/8	6 1/8	6 1/8	50.00	600,000

- Refer to DuPont Refrigerant Expert, version 2.0 for actual velocities and pressure drops.
- Equivalent length is actual length plus friction losses caused by fittings and accessories.
- Line sizes are expressed in outside diameter of type “L” copper tubing.
- Line sizes are calculated at rated full load system capacity.
- All selections are based on a maximum of 65° F return gas entering the compressor and a refrigerant condensing and liquid line temperature of 105° F.



Freon 502 Refrigerant Piping Guide



		Discharge Line Size Compressor to Condenser <small>1F° (3.2 psi) pressure drop maximum</small>					Liquid Condensate Line Condenser to Receiver <small>Condensate drain / vent</small>					Liquid Line Size Receiver to TXV <small>1F° (3.2 psi) pressure drop maximum</small>						
System Capacity BTU/Hr.	System Capacity Tons/Hr	Equivalent Line Lengths ... feet															System Capacity Tons/Hr	System Capacity BTU/Hr.
		25	50	75	100	150	25	50	75	100	150	25	50	75	100	150		
18,000	1.50	1/2	5/8	3/4	3/4	3/4	1/2	1/2	5/8	5/8	5/8	3/8	3/8	1/2	1/2	1/2	1.50	18,000
24,000	2.00	5/8	3/4	3/4	3/4	7/8	1/2	5/8	5/8	5/8	5/8	3/8	1/2	1/2	1/2	1/2	2.00	24,000
30,000	2.50	5/8	3/4	3/4	7/8	7/8	5/8	5/8	5/8	5/8	3/4	1/2	1/2	1/2	1/2	5/8	2.50	30,000
36,000	3.00	3/4	3/4	7/8	7/8	1 1/8	5/8	5/8	5/8	3/4	3/4	1/2	1/2	1/2	5/8	5/8	3.00	36,000
42,000	3.50	3/4	7/8	7/8	7/8	1 1/8	5/8	5/8	3/4	3/4	3/4	1/2	1/2	5/8	5/8	5/8	3.50	42,000
48,000	4.00	3/4	7/8	7/8	1 1/8	1 1/8	5/8	3/4	3/4	3/4	7/8	1/2	5/8	5/8	5/8	3/4	4.00	48,000
60,000	5.00	7/8	7/8	1 1/8	1 1/8	1 1/8	5/8	3/4	3/4	7/8	7/8	1/2	5/8	5/8	3/4	3/4	5.00	60,000
92,000	7.50	1 1/8	1 1/8	1 1/8	1 3/8	1 3/8	3/4	7/8	7/8	7/8	1 1/8	5/8	3/4	3/4	3/4	7/8	7.50	92,000
120,000	10.00	1 1/8	1 1/8	1 3/8	1 3/8	1 3/8	3/4	7/8	1 1/8	1 1/8	1 1/8	5/8	3/4	7/8	7/8	7/8	10.00	120,000
150,000	12.50	1 1/8	1 3/8	1 3/8	1 3/8	1 5/8	7/8	1 1/8	1 1/8	1 1/8	1 3/8	3/4	7/8	7/8	7/8	1 1/8	12.50	150,000
180,000	15.00	1 3/8	1 3/8	1 5/8	1 5/8	1 5/8	7/8	1 1/8	1 1/8	1 3/8	1 3/8	3/4	7/8	7/8	1 1/8	1 1/8	15.00	180,000
240,000	20.00	1 3/8	1 5/8	1 5/8	2 1/8	2 1/8	1 1/8	1 3/8	1 3/8	1 3/8	1 3/8	7/8	1 1/8	1 1/8	1 1/8	1 1/8	20.00	240,000
300,000	25.00	1 3/8	1 5/8	2 1/8	2 1/8	2 1/8	1 1/8	1 3/8	1 3/8	1 3/8	1 5/8	7/8	1 1/8	1 1/8	1 1/8	1 3/8	25.00	300,000
360,000	30.00	1 5/8	2 1/8	2 1/8	2 1/8	2 1/8	1 3/8	1 3/8	1 3/8	1 5/8	1 5/8	1 1/8	1 1/8	1 1/8	1 3/8	1 3/8	30.00	360,000
420,000	35.00	1 5/8	2 1/8	2 1/8	2 1/8	2 5/8	1 3/8	1 3/8	1 5/8	1 5/8	1 5/8	1 1/8	1 1/8	1 3/8	1 3/8	1 3/8	35.00	420,000
480,000	40.00	1 5/8	2 1/8	2 1/8	2 1/8	2 5/8	1 3/8	1 5/8	1 5/8	1 5/8	2 1/8	1 1/8	1 3/8	1 3/8	1 3/8	1 5/8	40.00	480,000
540,000	45.00	2 1/8	2 1/8	2 1/8	2 5/8	2 5/8	1 3/8	1 5/8	1 5/8	1 5/8	2 1/8	1 1/8	1 3/8	1 3/8	1 3/8	1 5/8	45.00	540,000
600,000	50.00	2 1/8	2 1/8	2 5/8	2 5/8	2 5/8	1 3/8	1 5/8	1 5/8	2 1/8	2 1/8	1 1/8	1 3/8	1 3/8	1 5/8	1 5/8	50.00	600,000

- Refer to DuPont Refrigerant Expert, version 2.0 for actual velocities and pressure drops.
- Equivalent length is actual length plus friction losses caused by fittings and accessories.
- Line sizes are expressed in outside diameter of type “L” copper tubing.
- Line sizes are calculated at rated full load system capacity.
- All selections are based on a maximum of 65° F return gas entering the compressor and a refrigerant condensing and liquid line temperature of 105° F.

FREON "502" REFRIGERANT PRESSURE DROP IN LINES (65°F Evap. Outlet)

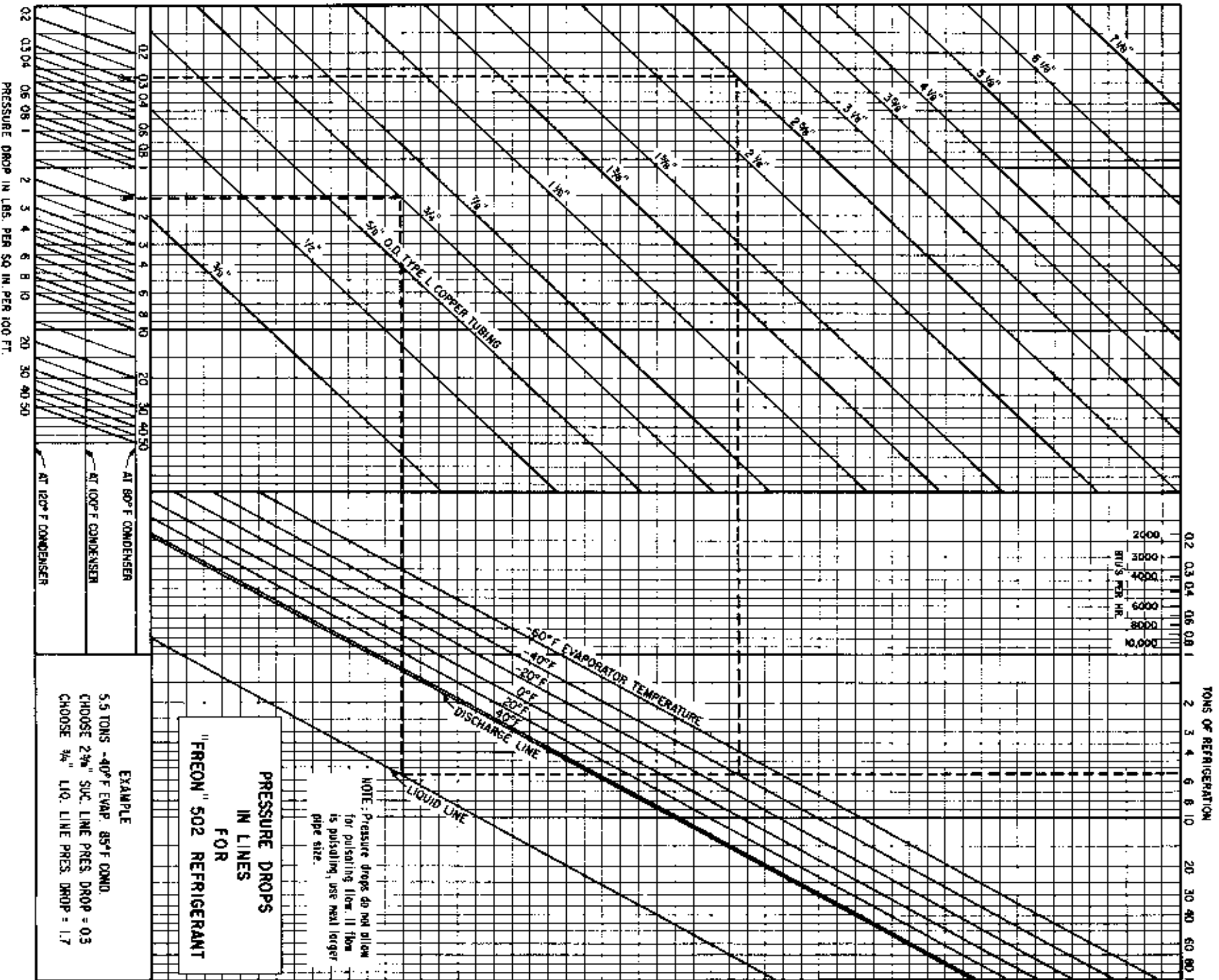

FREON "502" REFRIGERANT VELOCITY IN LINES (65°F Evap. Outlet)

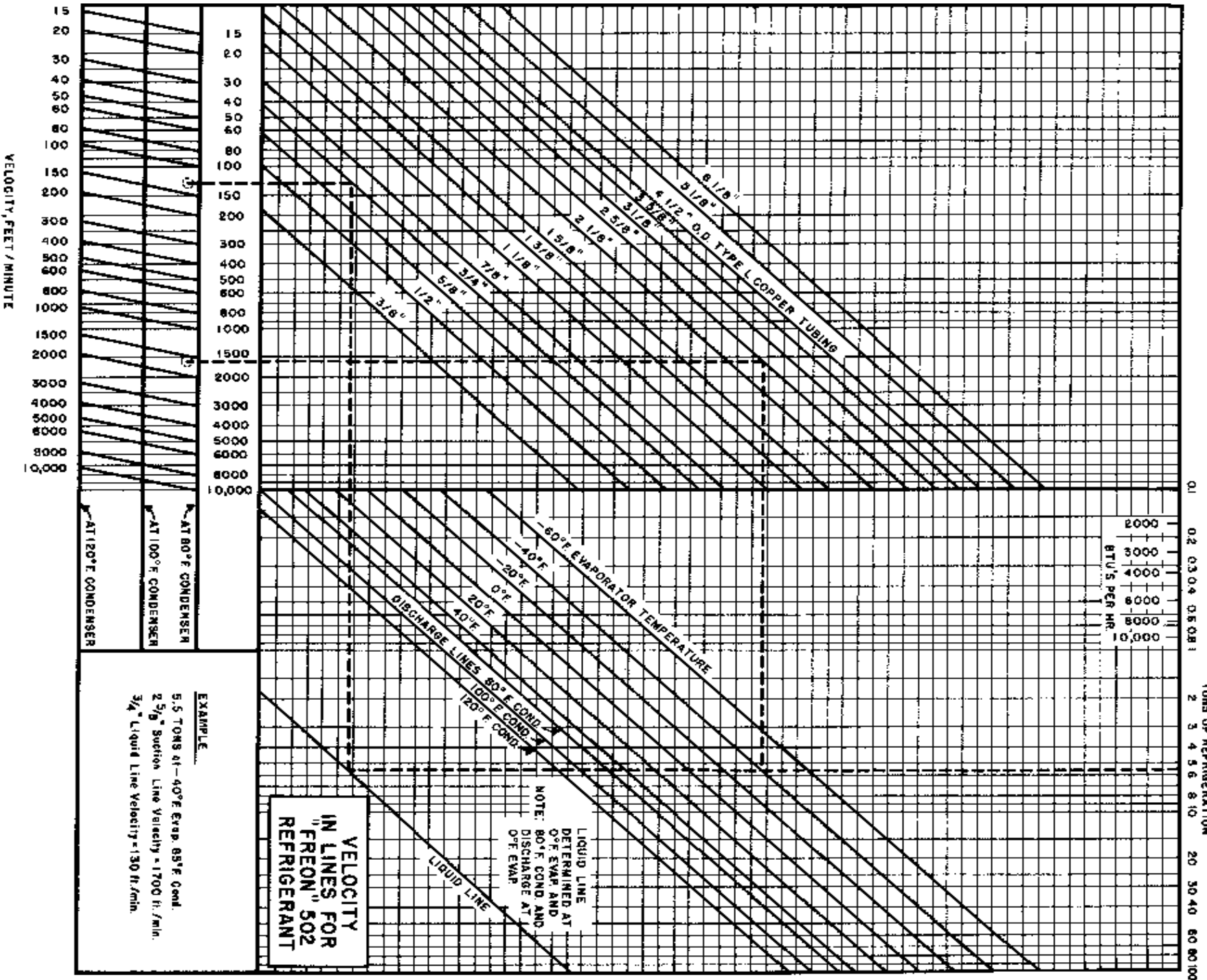



The miracles of science™

Suva[®]
refrigerants

Refrigerant

Freon 503 (R-503)

Piping Guide

From 12,000 BTU through 240,000 BTU per hour at -130° F through -60° F saturated suction temperature. (1.0 ton through 20.0 tons)

“Quick Pick”

Note:

This data is for the selection of the second stage refrigeration piping of a typical cascade refrigeration system ONLY. In the first stage use Suva 404A (R-404A) refrigerant and select the suggested pipe size from the Suva 404A (R-404A) refrigerant piping guide.



Freon 503 Refrigerant Piping Guide

Suction Line Size .. Evaporator to Compressor

		- 60° F through -100° F (67 through 17 psig)					- 101° F through - 115° F (17 through 7 psig)					- 116° F through - 130° F (6 psig through 2" Hg)						
		Suggested Allowable Pressure Drop in psig = 2F°																
		2.5 lbs. (2F°)					1.4 lbs. (2F°)					1.0 lbs. (2F°)						
System Capacity BTU/Hr.	System Capacity Tons/Hr	Equivalent Suction Line Lengths ... feet															System Capacity Tons/Hr	System Capacity BTU/Hr.
		25	50	75	100	150	25	50	75	100	150	25	50	75	100	150		
12,000	1.00	3/4	3/4	3/4	7/8		3/4	7/8	1 1/8	1 1/8		7/8	1 1/8	1 1/8	1 1/8		1.00	12,000
18,000	1.50	3/4	7/8	7/8	1 1/8		7/8	1 1/8	1 1/8	1 1/8		1 1/8	1 1/8	1 3/8	1 3/8		1.50	18,000
24,000	2.00	7/8	7/8	1 1/8	1 1/8	N/A	1 1/8	1 1/8	1 3/8	1 3/8	N/A	1 1/8	1 3/8	1 3/8	1 5/8		2.00	24,000
30,000	2.50	7/8	1 1/8	1 1/8	1 1/8		1 1/8	1 3/8	1 3/8	1 3/8		1 3/8	1 3/8	1 5/8	1 5/8	N/A	2.50	30,000
36,000	3.00	1 1/8	1 1/8	1 1/8	1 3/8		1 1/8	1 3/8	1 3/8	1 5/8		1 3/8	1 5/8	1 5/8	2 1/8		3.00	36,000
42,000	3.50	1 1/8	1 1/8	1 3/8	1 3/8		1 1/8	1 3/8	1 5/8	1 5/8		1 3/8	1 5/8	2 1/8	2 1/8		3.50	42,000
48,000	4.00	1 1/8	1 1/8	1 3/8	1 3/8		1 3/8	1 3/8	1 5/8	1 5/8		1 5/8	1 5/8	2 1/8	2 1/8		4.00	48,000
60,000	5.00	1 1/8	1 3/8	1 3/8	1 3/8		1 3/8	1 5/8	1 5/8	2 1/8		1 5/8	2 1/8	2 1/8	2 1/8		5.00	60,000
92,000	7.50	1 3/8	1 5/8	1 5/8	1 5/8	N/A	1 5/8	2 1/8	2 1/8	2 1/8	N/A	2 1/8	2 1/8	2 5/8	2 5/8	N/A	7.50	92,000
120,000	10.00	1 5/8	1 5/8	2 1/8	2 1/8		2 1/8	2 1/8	2 1/8	2 5/8		2 1/8	2 5/8	2 5/8	2 5/8		10.00	120,000
180,000	15.00	2 1/8	2 1/8	2 1/8	2 1/8		2 1/8	2 5/8	2 5/8	2 5/8		2 5/8	2 5/8	3 1/8	3 1/8		15.00	180,000
240,000	20.00	2 1/8	2 1/8	2 5/8	2 5/8		2 1/8	2 5/8	2 5/8	3 1/8		2 5/8	3 1/8	3 5/8	3 5/8		20.00	240,000
300,000	25.00																25.00	300,000
360,000	30.00																30.00	360,000
420,000	35.00	N/A	N/A	N/A	N/A	N/A	N/A	N/A	N/A	N/A	N/A	N/A	N/A	N/A	N/A	N/A	35.00	420,000
480,000	40.00																40.00	480,000
540,000	45.00																45.00	540,000
600,000	50.00																50.00	600,000

- Refer to DuPont Refrigerant Expert, version 2.0 for actual velocities and pressure drops.
- Equivalent length is actual length plus friction losses caused by fittings and accessories.
- Line sizes are expressed in outside diameter of type “L” copper tubing.
- Line sizes are calculated at rated full load system capacity.
- All selections are based on a maximum of - 60° F return gas entering the compressor and a refrigerant condensing and liquid line temperature of - 20° F.



Freon 503 Refrigerant Piping Guide



		Discharge Line Size Compressor to Condenser <small>1F° (3.1 psi) pressure drop maximum</small>					Liquid Condensate Line Condenser to Receiver <small>Condensate drain / vent</small>					Liquid Line Size Receiver to TXV <small>1F° (3.1 psi) pressure drop maximum</small>						
System Capacity BTU/Hr.	System Capacity Tons/Hr	Equivalent Line Lengths ... feet															System Capacity Tons/Hr	System Capacity BTU/Hr.
		25	50	75	100	150	25	50	75	100	150	25	50	75	100	150		
12,000	1.00	1/2	5/8	5/8	5/8		1/2	1/2	1/2	1/2		3/8	3/8	3/8	3/8		1.00	12,000
18,000	1.50	5/8	5/8	3/4	3/4		1/2	1/2	5/8	5/8		3/8	3/8	1/2	1/2		1.50	18,000
24,000	2.00	5/8	3/4	3/4	7/8	N/A	1/2	5/8	5/8	5/8	N/A	3/8	1/2	1/2	1/2	N/A	2.00	24,000
30,000	2.50	3/4	3/4	7/8	7/8		1/2	5/8	5/8	5/8		3/8	1/2	1/2	1/2		2.50	30,000
36,000	3.00	3/4	7/8	7/8	1 1/8		5/8	5/8	5/8	3/4		1/2	1/2	1/2	5/8		3.00	36,000
42,000	3.50	3/4	7/8	1 1/8	1 1/8		5/8	5/8	3/4	3/4		1/2	1/2	5/8	5/8		3.50	42,000
48,000	4.00	7/8	7/8	1 1/8	1 1/8		5/8	5/8	3/4	3/4		1/2	1/2	5/8	5/8		4.00	48,000
60,000	5.00	7/8	1 1/8	1 1/8	1 1/8		5/8	3/4	3/4	3/4		1/2	5/8	5/8	5/8		5.00	60,000
92,000	7.50	1 1/8	1 1/8	1 3/8	1 3/8	N/A	3/4	3/4	7/8	7/8	N/A	5/8	5/8	3/4	3/4	N/A	7.50	92,000
120,000	10.00	1 1/8	1 3/8	1 3/8	1 3/8		3/4	7/8	7/8	1 1/8		5/8	3/4	3/4	7/8		10.00	120,000
180,000	15.00	1 3/8	1 5/8	1 5/8	1 5/8		7/8	1 1/8	1 1/8	1 3/8		3/4	7/8	7/8	1 1/8		15.00	180,000
240,000	20.00	1 3/8	1 5/8	2 1/8	2 1/8		1 1/8	1 1/8	1 3/8	1 3/8		7/8	7/8	1 1/8	1 1/8		20.00	240,000
300,000	25.00	N/A	N/A	N/A	N/A	N/A	N/A	N/A	N/A	N/A	N/A	N/A	N/A	N/A	N/A	N/A	25.00	300,000
360,000	30.00																30.00	360,000
420,000	35.00	N/A	N/A	N/A	N/A	N/A	N/A	N/A	N/A	N/A	N/A	N/A	N/A	N/A	N/A	N/A	35.00	420,000
480,000	40.00																40.00	480,000
540,000	45.00																45.00	540,000
600,000	50.00																50.00	600,000

- Refer to DuPont Refrigerant Expert, version 2.0 for actual velocities and pressure drops.
- Equivalent length is actual length plus friction losses caused by fittings and accessories.
- Line sizes are expressed in outside diameter of type “L” copper tubing.
- Line sizes are calculated at rated full load system capacity.
- All selections are based on a maximum of - 60° F return gas entering the compressor and a refrigerant condensing and liquid line temperature of - 20° F.



Suva[®]

refrigerants

The DuPont Company assumes no obligations or liability for any advice furnished or for any results obtained with respect to this information. All such advice is given and accepted at buyers risk. This disclosure of information herein is not a license to operate under, or a recommendation to infringe any patent of DuPont or others.